

Canon

Mk1500

CABLE ID PRINTER

User's Guide



Please read this guide before operating this product.
After you finish reading this guide, store it in a safe place for future reference.

Trademarks

- "Canon" and the Canon logo are the registered trademarks or the trademarks of Canon Inc.

Notices

- The contents of this document may not be duplicated in whole or in part by any means without permission.
- The information in this document is subject to change without notice.
- In no event shall Nisca Corporation bear any responsibility for any direct or indirect damages arising from the use of our product.
- In no event shall Nisca Corporation bear any responsibility for any direct or indirect damages resulting from the improper use of our product by the customer, or from modifications or changes made to our product by the customer.
- If you find any errors or omissions in this document, or if you have any questions concerning this document, contact your nearest dealer.
- The data created/saved with this printer cannot be backed up in another storage device such as the hard disk of the PC. We assume no responsibility for the loss caused by data disappearance due to a machine failure, repair, inspection, or weak battery as well as the carry-over loss.

Copyright ©2015 Nisca Corporation all rights reserved.

A Vital Tool for Electrical Facilities

Introducing the Mk1500

When you open a power distribution panel, you are confronted with an array of tightly packed terminals, circuit breakers, and switches, and these myriad devices are connected by a maze of cables. If each device and cable is not clearly labeled with a symbol or a number, maintenance can become a nightmare. In such electrical facilities, it is common practice to use printed tube to identify cables and printed labels to identify switches. The Mk1500 is used to print such labels and tube.

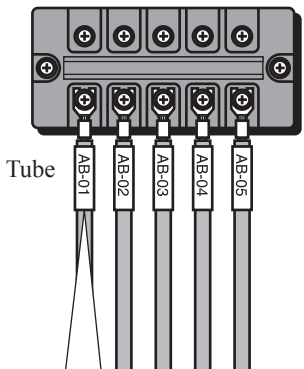

Easy yet high-quality printing

Printing tube

The Mk1500 can print tube that identify cables: “AB-01” or “+20V”, for example. Because the tube that is used is available commercially, the Mk1500 provides an economical solution. The Mk1500 can also be used to print on heat shrink tube and 4mm I.D. strip.

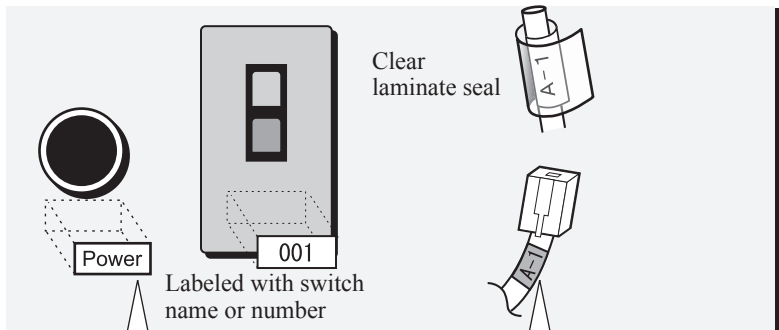

Label switches clearly

Printing labels

The Mk1500 can also be used to print label tape (sold separately). Because labels that correspond to specific cable tube labels can be printed and applied to the corresponding devices, using such labels results in improved efficiency.

Label with clear adhesive lamination

Wrap-around tape with printable and laminating layers

When applied after printing, the printing is covered by plastic laminating film, protecting the characters from scratching. Adheres to cables after they have been connected.

Main Features

1 Compact and easy to carry

In addition to being compact at 250 mm (W) x 300 mm (D) x 85 mm (H), the printer also has a lightweight design (2kg), making it easy to transport to the site of electrical facilities. Overall, the printer greatly increases work efficiency.

2 Supports a variety of printing media

The printer can print on commercially available tube, label tape, heat shrink tube, wrap around tape, and 4mm I.D. strip.

3 Legible printing even in cool environments

Install the optional Tube Warmer to print legibly in environments as cool as 5°C.

4 Many functions not normally found in a hand-portable machine

Includes a variety of standard features such as adjustable character size, spacing and margins, and file saving capabilities that are hard to imagine in such a light-weight machine.

Contents

Explanation of Symbols	4
Safety Precautions	5
Quick Guide to Using the Printer	12

Part 1 *Before You Begin (Preparation)*

1.1 Names and Functions of Parts	18
Main Unit	18
LCD screen	20
Keyboard	21
1.2 Connecting the AC Adapter.....	23

Part 2 *Basic Operations*

2.1 Printing on Tube and Clear Tube.....	26
Prep 1 Install cassettes	26
Prep 2 Insert tube	28
Prep 3 Turn the power switch on	29
Step 1 Input characters	30
Step 2 Print	33
2.2 Printing on Label Tape, Heat Shrink Tube, and 4mm I.D. Strip	34
Prep 1 Install cassettes	34
Prep 2 Turn the power switch on	37
Step 1 Input characters	38
Step 2 Print	41
2.3 Printing on Wrap-around Tape	42
Prep 1 Installing the cassettes	42
Prep 2 Installing the wrap-around tape guide.....	43
Prep 3 Turn the power switch on	44
Step 1 Input characters	45
Step 2 Print	47

Part 3 *Character Input*

3.1 Inputting Characters	50
Inputting characters	50
3.2 Inputting Symbols	51
Inputting symbols.....	51
3.3 Deleting Characters, Creating New Pages, Moving the Cursor	52
Deleting or changing characters.....	52
Deleting all entered text data.....	53
Creating a new page	53
Inserting a page	54
Deleting a page	54
Moving the cursor	55

Part 4 *Advanced Operations*

4.1 Changing the Characters and the Number of Lines	58
Changing character size.....	58
Changing the spacing between characters	59
Adding an underline to “6” and “9”	60
Adding a frame to characters.....	61
Printing on two lines	62
4.2 Saving, Retrieving and Deleting Character Data	64
Files	64
Saving character data.....	65
Loading character data.....	66
Deleting character data	67

4.3 Various Printing Functions	68
Printing count	68
Changing the printing orientation	70
Changing the length and the character alignment	72
Printing a specific page multiple times (Continuous Print)	74
Generating sequential characters (serial printing)	76
Adjusting the printing start position and vertical position	79
Adjusting the printing density	81
4.4 Changing the Cutting Method	82
Half cuts and full cuts	82
Turning off half cuts	82
4.5 Other Operations	84
Removing the print media	84
Changing the display contrast	86
Restoring the initial settings.....	87
Increasing the printing speed	88

Part 5 *Maintenance*

5.1 If a Tube or Label Tape Becomes Jammed	90
Action to Take against Media Jam (When the “Media JAM” message is displayed).....	90
Actions to Take against Other Jams (When the “Media JAM” message is not displayed).....	92
When a Tube or Label Tape is Not Ejected/Fed.....	94
5.2 What To Do If the Cutter Is Getting Blunt.....	96
Changing the cutting depth	96
5.3 Replacing the Cutter	98
5.4 Replacing the Cassette.....	100
Replacing the ribbon cassette	100
Replacing a tube or the label tape cassette.....	101
5.5 Maintenance	102
Cleaning the printer.....	102
Cleaning the transport rollers	102
Cleaning the print head	104
Cleaning/Replacing the tube cleaner	104

Part 6 *Appendices*

6.1 Consumable Supplies and Options	106
Consumable supplies	106
Options.....	107
6.2 Message List	108
6.3 Troubleshooting.....	109
6.4 List of Symbols	111
6.5 List of Function	112
6.6 Main Specifications	113

Explanation of Symbols

The meanings of the symbols that are used in this manual are explained below.

 **WARNING** A precaution to be followed to use the printer in safe is written. Failure to follow it can result in fatal or serious injury. Be sure to follow it.

 **CAUTION** A precaution to be followed to use the printer in safe is written. Failure to follow it can result in an injury. Be sure to follow it.

CAUTION A precaution to be followed to use the printer properly is written. Failure to follow it can break the printer or damage other products. Be sure to follow it.

 **important** An important notice or restriction to be followed to prevent troubles due to improper operation is written. Be sure to read it.

 **Note** Supplementary information is provided to facilitate operation.

Memo Supplementary information about the operational procedure is written.

 Indicates a page that should be referenced in regards to a specific operation. Refer to the information on that page.

[] Indicates a key that should be pressed on the keyboard.

Safety Precautions

In order to ensure safe operation of the printer, be certain to observe the following safety precautions.

important The shape of the power plug varies according to country.

WARNING

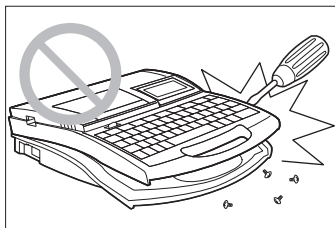

Do not disassemble or modify the unit

Disassembling or modifying the unit could cause a fire or damage the unit.

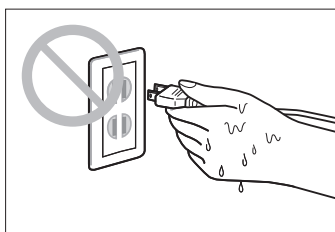

Do not handle the power cord with wet hands

Do not attempt to plug in or unplug the AC adapter plug, etc., while your hands are wet. Doing so could result in electric shock.

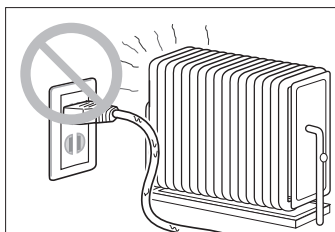

Do not place the unit in the vicinity of heating devices

Do not place the unit or the AC adapter cord in the vicinity of heating devices. Doing so could cause the unit or the cord to melt, which could result in fire or electric shock.

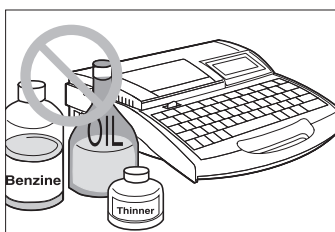

Keep away from paint thinner, etc.

Do not place the unit near alcohol, paint thinner, or other flammable solvents. The solvents could come into contact with internal electric components and cause a fire or electric shock.

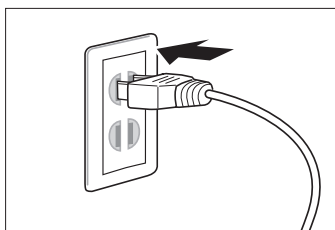

Plug the power cord in securely

Be sure to plug the AC adapter plug into the power outlet securely. Failing to do so could result in a fire or electric shock.

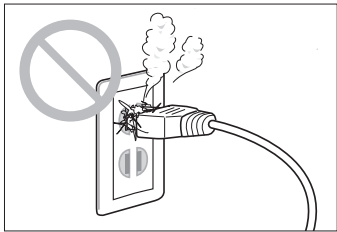

Always keep the AC plug clean

Clean the AC adapter plug periodically. If dust, dirt, soot, etc., is allowed to accumulate on the plug, the dust could absorb moisture, creating an insulation fault that could cause a fire.

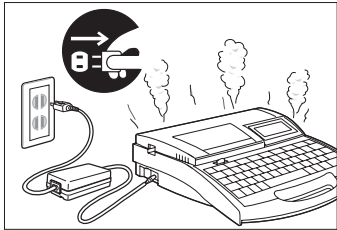

Do not continue to use the unit if an abnormality develops

If the unit begins to smoke or emit an unusual odor, turn the power switch off immediately, unplug the AC adapter plug from the power outlet, and then contact your nearest dealer. Continuing to use the unit after an abnormal condition has developed could result in fire or electric shock.

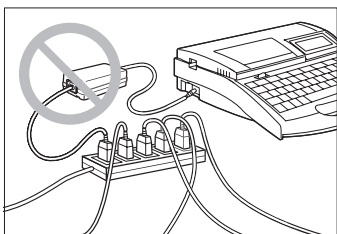

Do not connect to a multi-outlet adapter or extension cord

Do not connect this unit to a multi-outlet adapter or extension cord.

Doing so could result in fire or electric shock.

Do not power on with the power cord tied. It can cause fire or electrical shock.

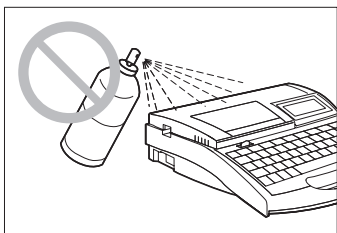

Do not use sprays, etc., in the vicinity of the unit

Do not use flammable sprays in the vicinity of this unit. The spray could come into contact with internal components of the unit, resulting in a fire or electric shock.

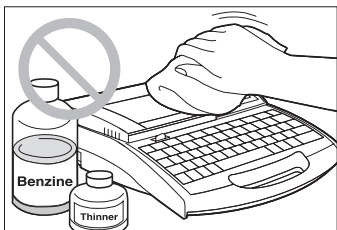

Do not clean with paint thinner, etc.

If it is necessary to wipe dirt off the unit, use gauze that has been dampened with water and then thoroughly wrung out. Never use flammable solvents such as alcohol, benzene or paint thinner. The solvents could come into contact with internal electric components and cause a fire or electric shock.

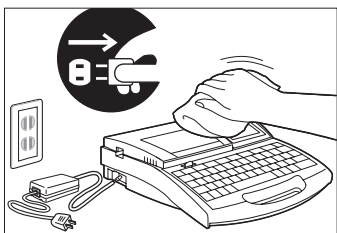

Turn the unit off for cleaning

Before cleaning the unit, turn the power off and unplug the AC adapter from the power outlet. Injury could result if the power switch is inadvertently left in the "ON" position and the unit is put into operation.

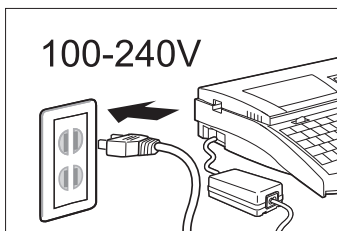

Use a 100-240V AC power supply

Use only at the indicated power voltage.

Use at voltage between 100 and 240V AC. If not, it may result in fire, electrical shock or machine failure.

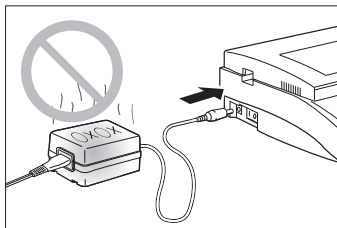

Do not use any AC adaptor or cord other than the included one

Never use any other AC adaptor (N14584) or cord than the included one. Using it can result in fire, electric shock, or printer failure. Do not use the included AC adaptor for any other product. Fire or electric shock can result.

When it thunders at a short distance, remove the power plug from the outlet

When it thunders at a short distance, remove the power plug from the outlet. If not, it may result in fire, electric shock, or machine failure.

Do not damage the AC adapter and cord

Do not damage, pull excessively, or modify the AC adapter and cord. Do not place a heavy thing on the AC adapter and cord. A short-circuit can be caused at the damaged portion, resulting in a fire or electric shock.

! CAUTION

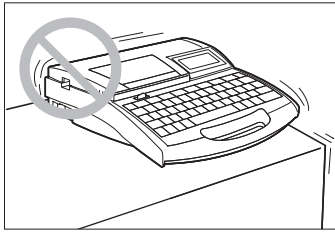

Do not place the unit on an unstable surface

Do not place the unit on an unstable surface or a surface that is subject to vibration. The unit could fall or tip over and cause injury.

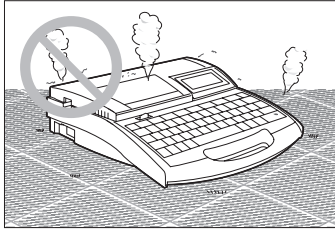

Do not place the unit on a carpet

Do not place the unit directly on a rug or carpet. Fibers and dust from the carpet can get inside of the unit and cause a fire.

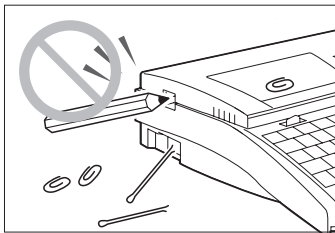

Do not insert foreign objects inside the unit

Do not drop or insert foreign objects such as clips or staples in the opening for the AC adaptor, cutter section, or inside the printer. Otherwise it may cause fire, electrical shock, machine failure, or injury.

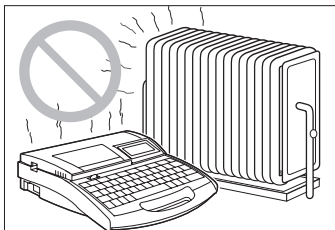

Protect the unit from humidity and dust

Do not operate or store the unit in a hot and humid environment, in a dusty environment, in an area exposed to direct sunlight, or near an open flame. Doing so could result in fire or electric shock.

Be sure to observe the storage and operating environment condition.

Operating environment: 15-32.5°C, RH 10-85%

Storage environment: 5-35°C, RH 10-90%

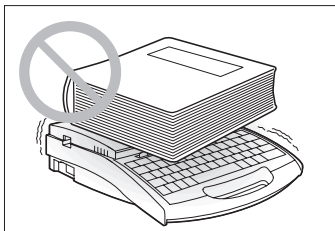

Do not place heavy objects or metal objects on the unit

Do not place heavy objects on the unit. Doing so could damage the unit.

Do not place metal objects such as accessories or containers such as cup containing water or fluid. Touching the electrical parts inside the printer can cause short circuit and may result in fire or electrical shock.

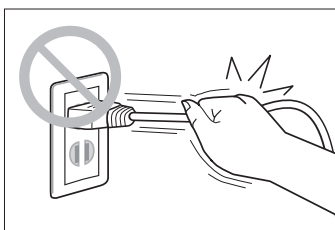

Handle the AC adapter carefully

When unplugging the power cord from an outlet, grasp the plug itself; do not pull on the cord. Pulling on the cord could damage the cord, which could result in fire or electric shock. Furthermore, always be sure to turn the power switch on the unit "OFF" before unplugging or plugging in the AC adapter.

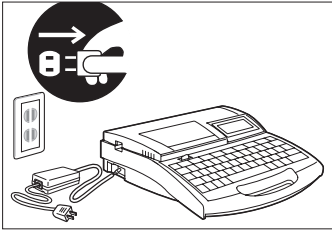

Unplug the unit when not in use

If the machine will not be used for a long time, unplug the AC adapter from the power outlet. Otherwise, electrical leakage may occur, and fire could result if dust has accumulated.

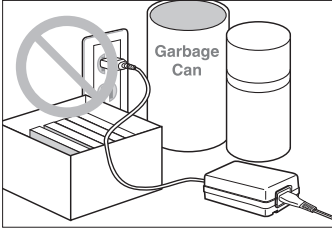

Keep the area around the AC adapter clear

In order to allow you to unplug the AC adapter quickly in an emergency, do not place other objects around the outlet. Inability to unplug the unit quickly in an emergency could result in fire or electric shock.

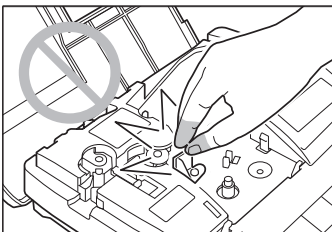

Do not touch the print head

Do not touch the print head while it is printing or immediately after printing. Doing so could result in a burn.

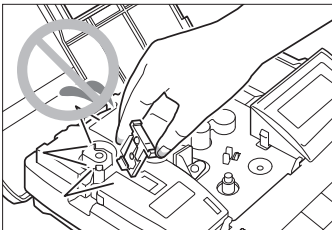

Do not touch the cutter

This unit has a built-in cutter. To avoid injury, read this manual thoroughly and handle the cutter carefully.

Keep small children away from the consumable

Always keep the consumable such as ribbon cassette, cleaner, etc., out of the reach of small children to avoid accidents.

Securely hold the handle of the printer

To avoid personal injury, securely hold the handle of the printer when carrying it.

CAUTION

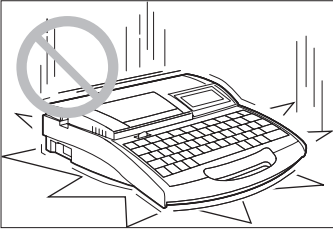

Handle the unit gently

Do not subject the unit to strong impacts. Doing so could damage the unit.



Do not operate the keyboard roughly

Do not handle the keyboard roughly when typing. Rough handling could result in damage to the unit.

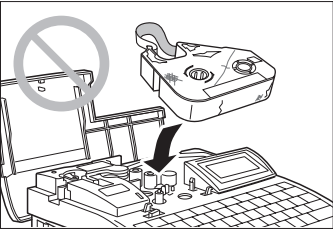

Do not re-use ribbons or label tape

Do not attempt to re-use ribbons or label tape. Doing so could damage the unit.

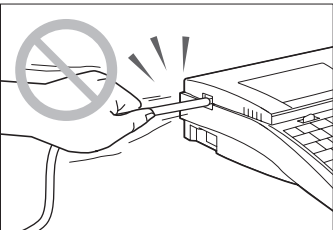

Do not attempt to pull tube out

Do not pull on a tube or tape while printing is in progress. Doing so could result in poor printing quality or malfunction.

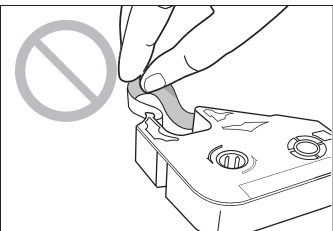

Do not touch ink ribbon

To avoid poor printing results with oil on your skin or staining your hands, do not touch ink ribbon.

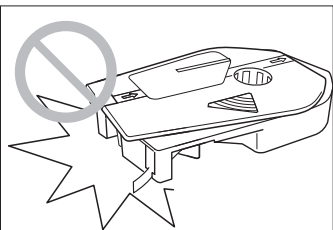

Using only cassettes designed for this unit

Use only the specified types of ribbon cassettes, tube attachments, etc. Never try to disassemble a cassette and install a new ribbon. Doing so can result in poor printing quality or damage to the equipment.

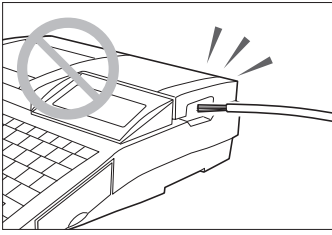

Do not feed wires into the unit

The purpose of this unit is to print on tube or labels. This unit cannot print directly on wires or cables, so do not attempt to feed wires or cables into the unit. Doing so could result in damage to the unit.

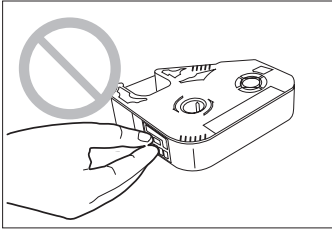

Do not touch the connector (metal part)

Do not touch the connection terminal (metal part) of the cassette. Doing so could cause an improper recognition of the cassette.

Do not leave the machine unused for a long time

Do not leave the printer in a sun-heated vehicle or any other extreme environment for an extended period.

Quick Guide to Using the Printer

This section explains the basic use of the printer for people who want to start using it quickly. Although the printer features a wide variety of functions, this section explains only the most basic sequence of operations: installing accessories → turn the power switch on → inputting characters → printing. Refer to the main body of this manual for more specific details on the functions of the printer.

Installing Accessories

1 Check that the power switch is turned off.

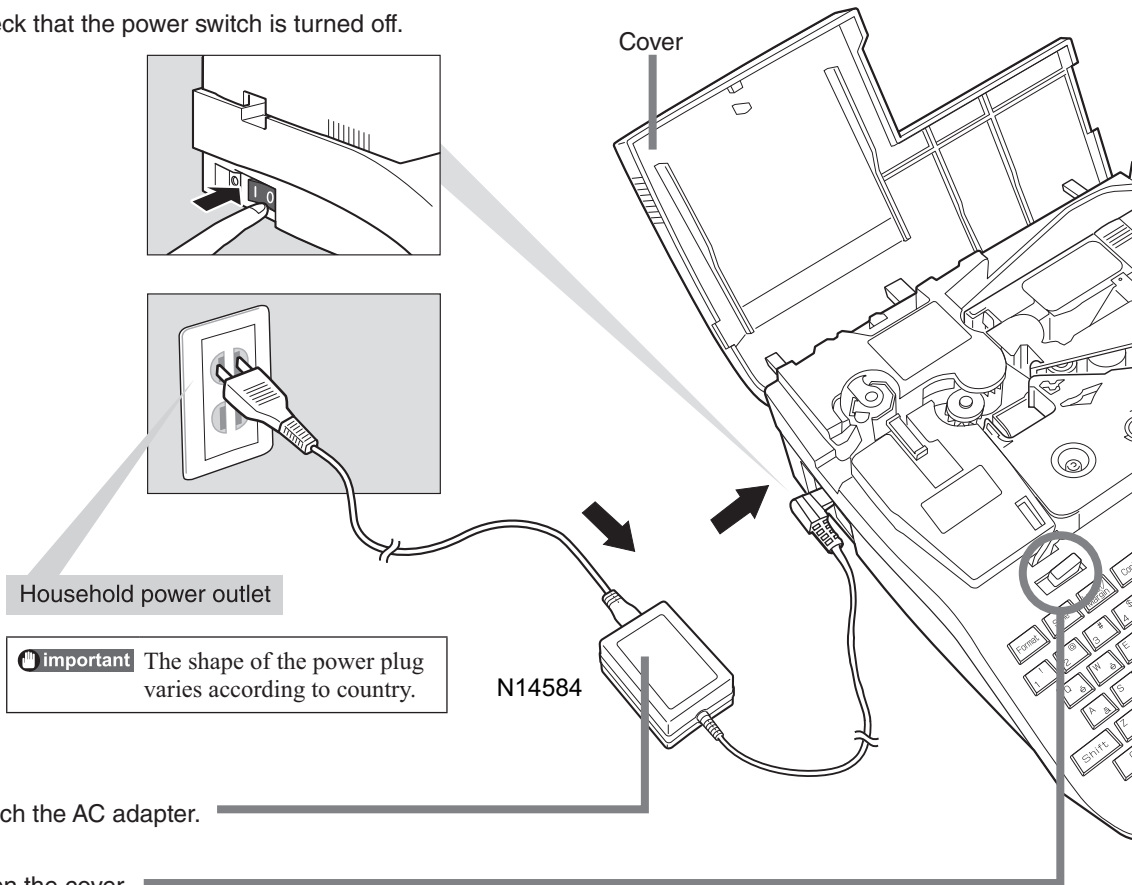

Household power outlet

important The shape of the power plug varies according to country.

N14584

2 Attach the AC adapter.

3 Open the cover.

- Move this lever to the left, and then open the cover.

4 Install the ribbon cassette.

- Remove the stopper and take up any slack in the ribbon.
- Push the cassette in until it clicks into place.

CAUTION Do not touch the connector (metal part)
Do not touch the connection terminal (metal part) of the cassette. Doing so could cause an improper recognition of the cassette.

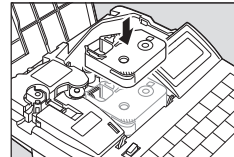
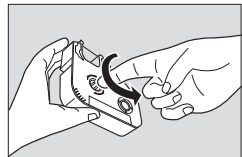
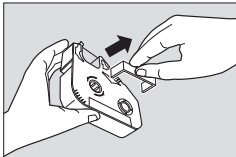

5 Install the tube attachment.

- Align the hooks on the tube attachment with the holes in the printer.
- Push the tube attachment in until it clicks into place.

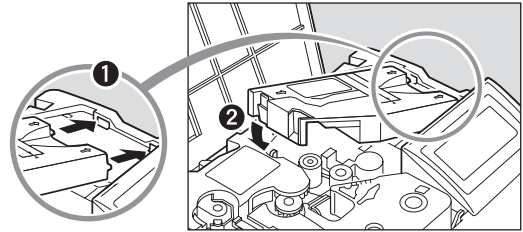

6 Insert a tube.

- Push the tube in until its tip touches transport roller 2.

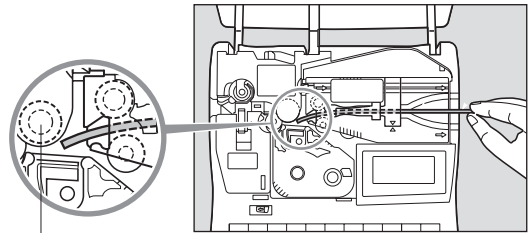

Transport roller 2

Turn the power switch on.

7 Close the cover.

- Close the cover completely so that it clicks shut.

8 Turn on the power switch.

- Character input display appears after displaying the ribbon cassette information.

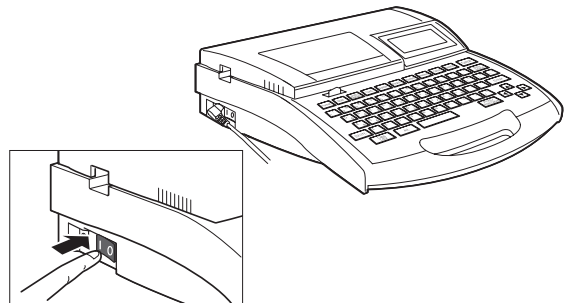

Inputting Characters

[Example] Printing “C-2” on a 3.0mm-diameter tube

Printed results 

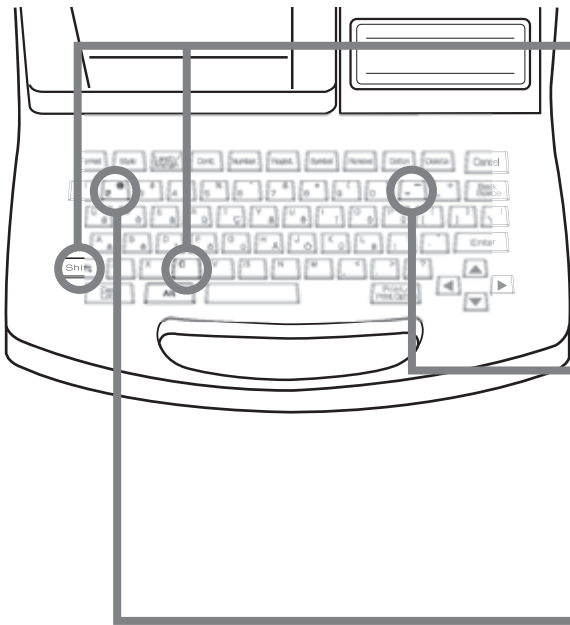

9 While holding down [Shift], press [C].

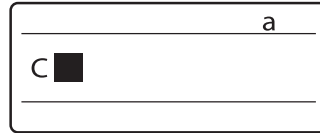

10 Press [-].

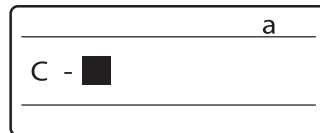

11 Press [2].

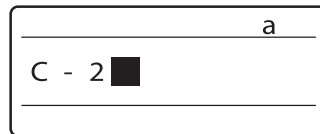

To delete a character

ex. Although you meant to enter “C-2”, you entered “C=2” by mistake.

1 Press [◀] and [▶], and move the cursor box to the position of the “2”.

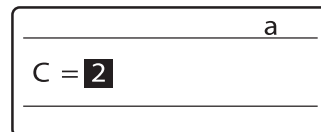

2 Press [Back Space].
• The “=” disappears.

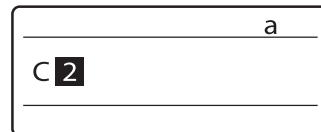

3 Press [-].

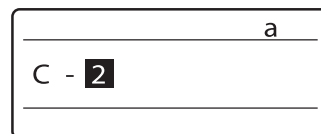

Printing

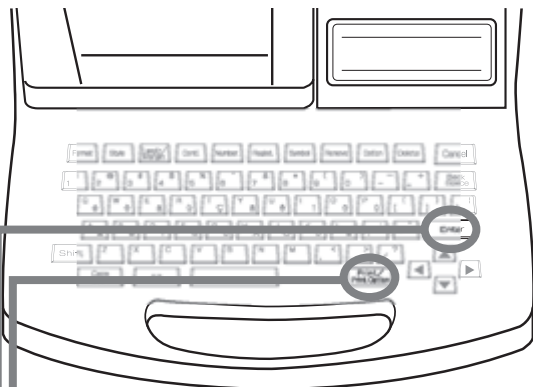

12 Press [Print/Print option].

- Make sure that “1:Tube” is selected.

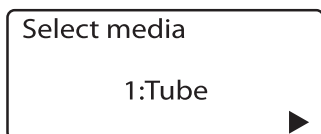

Memo “No ribbon cassette” is displayed if the ribbon cassette is not installed. Install the ribbon cassette.
 “No ribbon information. No ribbon amount displayed. Press enter” is displayed if the information cannot be read due to the ribbon cassette failure and so forth. If this message is displayed, follow the instruction on the screen.

13 Press [Enter].

- Make sure that “2:φ3.0mm” is selected.

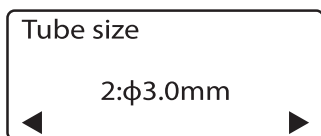

14 Press [Enter].

- Make sure that “No. to print” is “1”.

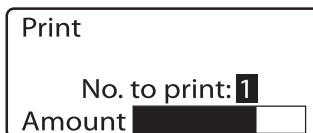

15 Press [Enter].

- Confirm that the leading end of the tube is fully inserted.

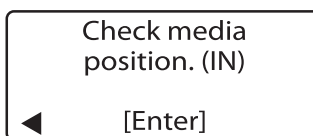

16 Press [Enter].

- The tube is automatically fed into the printer and printing begins.
- Once printing is completed, the tube is cut automatically.

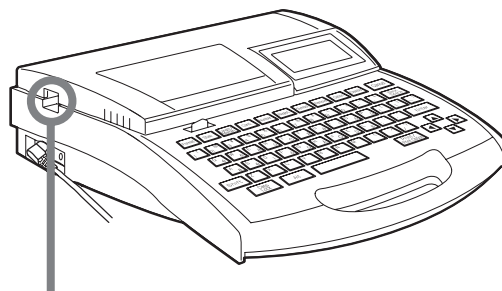
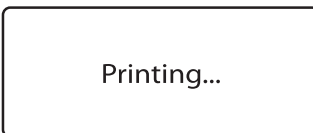

17 Take out the cut tube.

Part 1

Before You Begin (Preparation)

This section describes preparations and some things you should know before entering characters.

1.1	<i>Names and Functions of Parts</i>	18
	Main Unit.....	18
	LCD screen.....	20
	Keyboard.....	21
1.2	<i>Connecting the AC Adapter</i>	23

1.1 Names and Functions of Parts

Main Unit

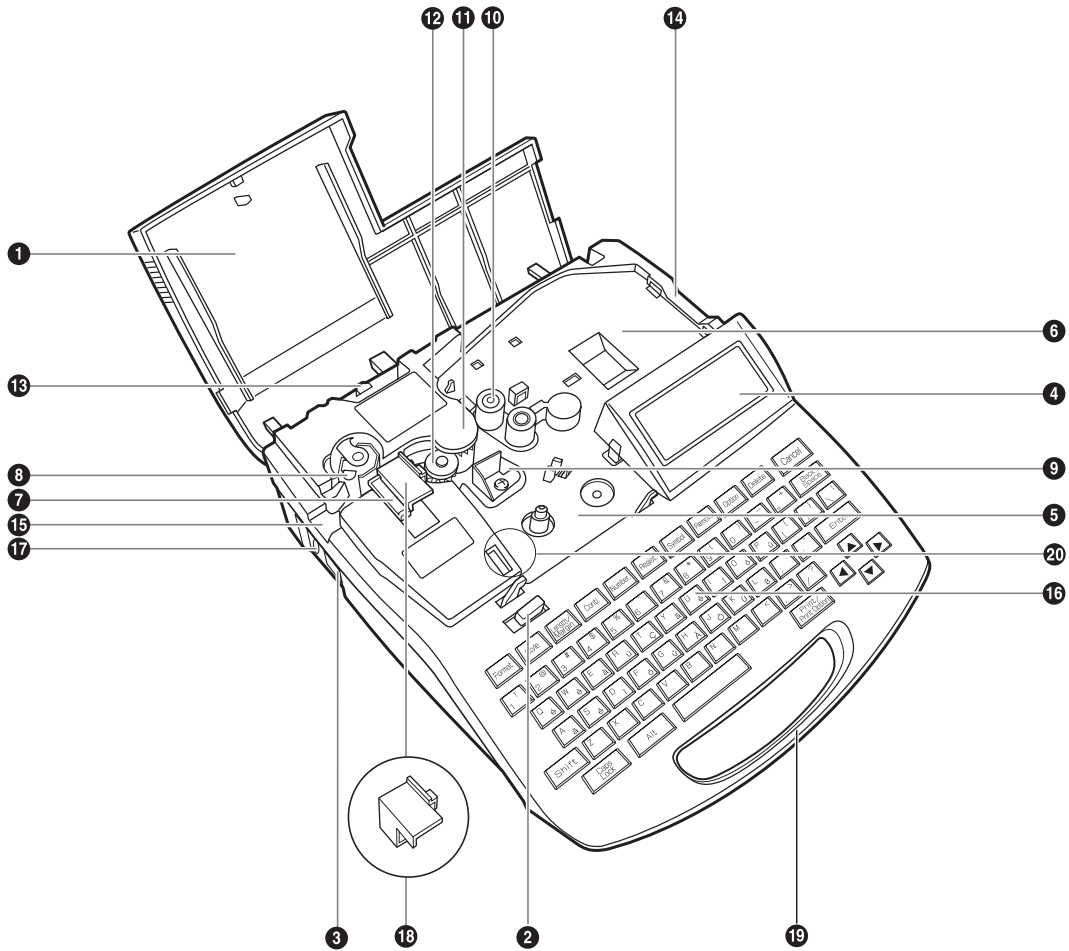

*Removing the wrap-around tape guide

To print to other media, remove the wrap-around tape guide 18.

1. Pull out the cutter.
2. Pull out the wrap-around tape guide.
3. Reinstall the cutter.

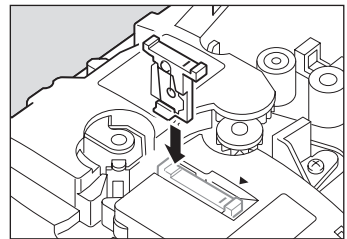
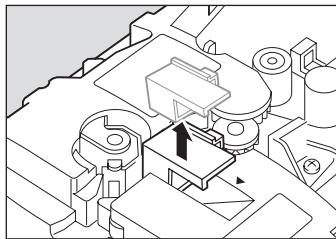
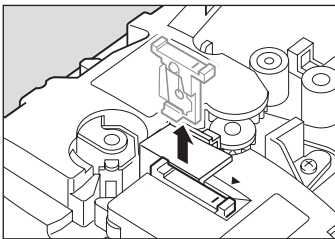

- 1 Cover**
Open this cover when you need to load a cassette or tube.
- 2 Cover release**
Pull this lever to the left to open the cover.
- 3 Power switch**
Use this switch to turn the power on and off. Flip the switch to the “|” position to turn the power on, and flip the switch to the “○” position to turn the power off.
- 4 LCD screen**
Displays text that has been input or the information about settings.
- 5 Ribbon cassette holder**
Place the ribbon cassette here.
- 6 Mounting location for tube attachment or printing media cassette**
Mount the tube attachment or label tape cassette here. The optional Tube Warmer also mounts here.
- 7 Cutter**
The cutter cuts printing media automatically. The cutter can be replaced.
- 8 Cutter receiver**
This is the receiver for the cutter blade when cutting printing media. When the cutter is replaced, the cutter receiver is replaced at the same time.
- 9 Print head**
This device prints by applying heat to a ribbon. As it becomes very hot, not touch this device while printing is in progress or immediately after printing.
- 10 Transport roller 1**
This roller feeds printing media to the print head.
- 11 Transport roller 2**
This roller feeds printing media past the print head.
- 12 Transport roller 3**
This roller feeds printed printing media to the cutter.
- 13 Transport roller 3 release lever**
Pull this lever to the right to release transport roller 3. Use this lever when clearing jammed printing media.
- 14 Tube intake**
Insert tube here (when tube attachment installed).
- 15 Outlet**
Printed printing media emerge here.
- 16 Keyboard**
Input text to be printed and data for settings through this keyboard.
- 17 AC adapter connector**
Connect the AC adapter cable here.
- 18 Wrap-around tape guide**
This guide is installed when printing on wrap-around tape. Remove it when printing to other media.
- 19 Handle**
Hold this handle when carrying the printer.
- 20 Connector for ribbon cassette**
This is to read out information of the ribbon cassette. Do not touch and deform the connector.

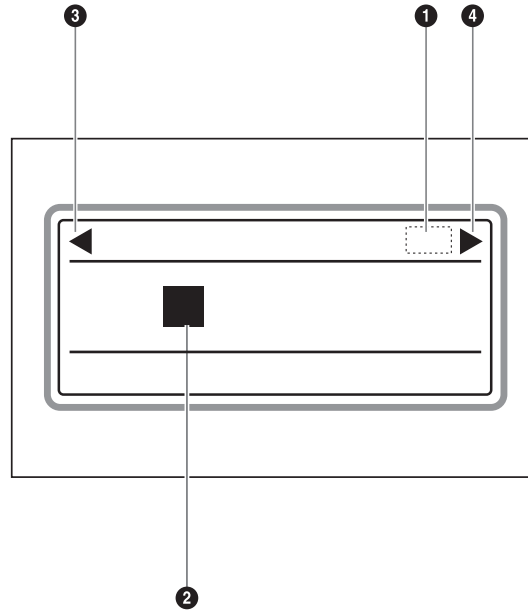

1 Caps Lock

Indicates whether the Caps Lock mode is active.

A: Active, so all alphabetic characters are entered in uppercase.

a: Normal(inactive)

2 Cursor

The cursor appears as a rectangle (■). Text is input at the cursor position.

3 Previous page indicator

Indicates that another page exists prior to the currently displayed page.

4 Next page indicator

Indicates that another page exists following the currently displayed page.

Keyboard

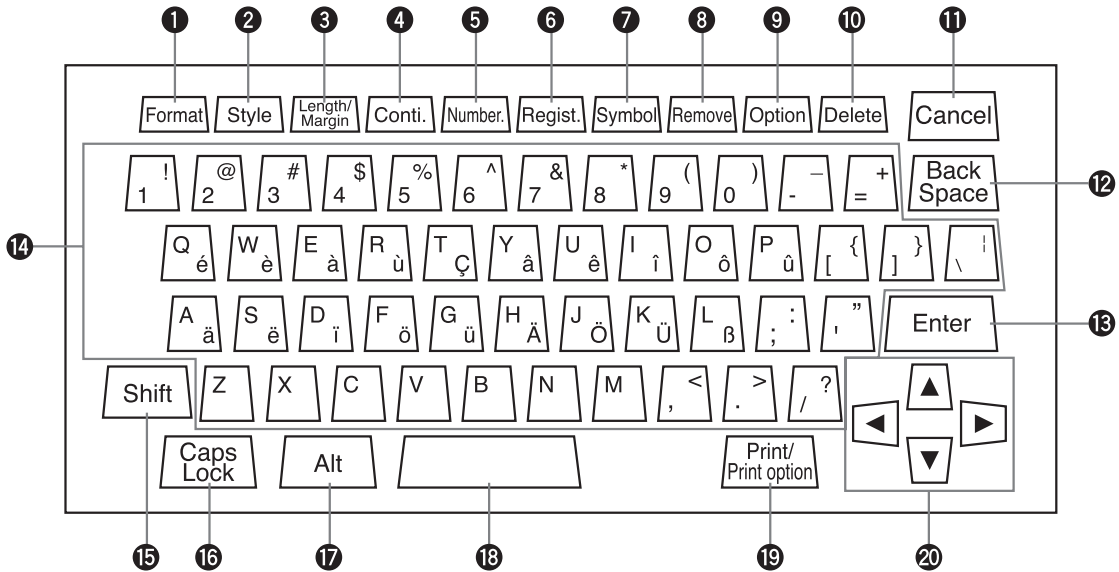

- 1** [Format] (📄 page 61, 70.)
This key is used to set the direction for printing text (horizontal/vertical) and to make the frame setting.
- 2** [Style] (📄 page 58, 62.)
This key is used to set the character size, number of lines, and spacing between characters.
- 3** [Length/Margin] (📄 page 73.)
This key is used to set the length of the media and the left and right margins.
- 4** [Conti.] (Continuous Printing) (📄 page 74.)
This key is used to set continuous printing.
- 5** [Number.] (Numbering) (📄 page 76.)
This key is used to set serial number input.
- 6** [Regist.] (Registration) (📄 page 65.)
This key is used to register input data in the printer's memory. This key is also used to call up or delete registered data.
- 7** [Symbol] (📄 page 51.)
This key is used to input characters from the symbol list.
- 8** [Remove] (📄 page 84.)
This key is used to remove media.

- 9** [Option]
This key is used to set optional functions (for adjustment, maintenance mode, or print option).
- 10** [Delete] (🗑️ page 53.)
This key is used to delete all input data.
- 11** [Cancel]
 - This key is used to cancel settings or operations, and to return the display to the previous display.
 - This key is also used to cancel printing.
- 12** [Back Space]
 - This key is used to delete the character that precedes the cursor.
 - Press the [Shift] key and the [Back Space] key in order to delete an unwanted page which has no input data.
- 13** [Enter]
 - This key is used to finalize a selection made for a given setting.
 - This key is also used to insert a page break at the end of text in order to proceed to the next page.
 - Press the [Shift] key and [Enter] in order to add (insert) a new page between existing pages.
- 14** Input keys
These keys are used to input characters, numbers, and symbols.
- 15** [Shift]
This key is used in combination with the input keys to input upper-case characters and additional symbols.
- 16** [Caps Lock]
This key is used to switch between upper-case input mode and lower-case input mode.
- 17** [Alt]
This key is used to input characters with diacritical marks by holding down this key while pressing the corresponding character key.
- 18** [(Space)]
This key is used to input a space.
- 19** [Print/Print option]
 - This key is used to enter print mode and to make the print settings.
- 20** Cursor [◀][▶][▲][▼]
 - These keys are used to move the cursor in the direction indicated by the arrow. The [▲] and [▼] keys can only be used when the two-line setting is in effect.
[Shift] + [◀] moves the cursor to the first character on the previous page, and [Shift] + [▶] moves the cursor to the first character on the next page.
 - These keys are also used to make settings and to change set values.

1.2 Connecting the AC Adapter

- 1 Make sure that the power switch is off.

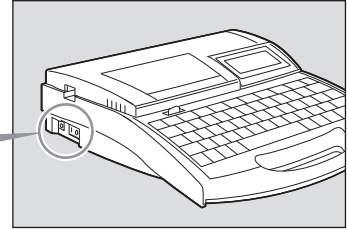

- 2 Plug the power cord into the AC adapter (N14584).
Plug it in all the way.

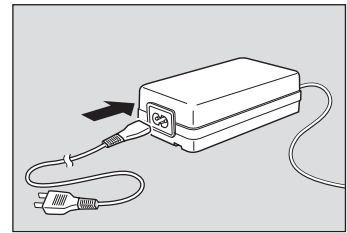

- 3 Plug the AC adapter into the printer.

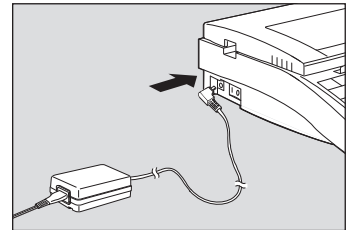

- 4 Plug the AC adapter power plug into a 100-240V power outlet.
Plug it in all the way.

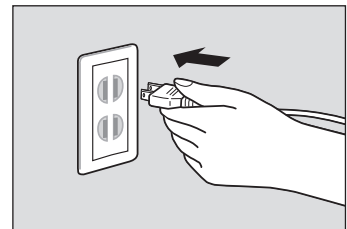

important The shape of the power plug varies according to country.



WARNING

Do not handle the power cord with wet hands

Do not plug in or unplug the AC adapter while your hands are wet. Doing so could result in electric shock.

Do not connect to a multi-outlet adapter or extension cord

Do not connect this unit to a multi-outlet adapter or extension cord. Doing so could result in fire or electric shock.

Do not power on with the power cord tied. It can cause fire or electrical shock.

Push the plug in all the way

Push the AC adapter power plug all of the way into the power outlet. Failure to do so could result in fire or electric shock.

Do not use any AC adaptor or cord other than the included one

Never use any other AC adaptor or cord than the included one. Using it can result in fire, electric shock, or printer failure. Do not use the included AC adaptor for any other product. Fire or electric shock can result.

Use a 100-240V AC power supply

Use at voltage between 100 and 240V AC. If not, it may result in fire, electrical shock or machine failure.

When it thunders at a short distance, remove the power plug from the outlet

When it thunders at a short distance, remove the power plug from the outlet. If not, it may result in fire, electric shock, or machine failure.

Do not damage the AC adapter and cord

Do not damage, pull excessively, or modify the AC adapter and cord. Do not place a heavy thing on the AC adapter and cord. A short-circuit can be caused at the damaged portion, resulting in a fire or electric shock.



CAUTION

Handle the AC adapter carefully

When unplugging the power cord from an outlet, grasp the plug itself; do not pull on the cord. Pulling on the cord could damage it, which could result in injury, fire or electric shock.

Keep the area around the AC adapter clear

In order to allow you to unplug the AC adapter quickly in an emergency, do not place other objects around the outlet. An inability to unplug the unit quickly in an emergency could result in fire or electric shock.

important

About the memory backup battery

If the memory backup battery starts become weak, the message shown below is displayed when the printer is turned on. If you continue to use the printer without replacing the battery, the memory backup battery will become completely dead, and the next time that the printer is turned off all data and settings will be lost. If this message appears, be sure to contact your dealer.

If the memory backup battery becomes completely dead, the message shown below is displayed when the printer is turned on. If this message appears, be sure to contact your dealer. If you continue to use the printer without replacing the battery, the printer may operate incorrectly.

Memory backup
battery low

Contact dealer.

After reading this message, press any key to continue.

Memory backup
battery exhausted.
Resetting memory.

Part 2

Basic Operations

This section describes the basic steps to take before printing.

2.1	<i>Printing on Tube and Clear Tube</i>	26
	Prep 1 Install cassettes	26
	Prep 2 Insert tube.....	28
	Prep 3 Turn the power switch on	29
	Step 1 Input characters	30
	Step 2 Print.....	33
2.2	<i>Printing on Label Tape, Heat Shrink Tube, and 4mm I.D. Strip</i>	34
	Prep 1 Install cassettes	34
	Prep 2 Turn the power switch on	37
	Step 1 Input characters	38
	Step 2 Print.....	41
2.3	<i>Printing on Wrap-around Tape</i>	42
	Prep 1 Installing the cassettes.....	42
	Prep 2 Installing the wrap-around tape guide	43
	Prep 3 Turn the power switch on	44
	Step 1 Input characters	45
	Step 2 Print.....	47

2.1 Printing on Tube and Clear Tube

The procedure for printing on tube or clear tube is shown below.

- Prep 1** Install cassettes
- ▼
- Prep 2** Insert tube
- ▼
- Prep 3** Turn the power switch on
- ▼
- Step 1** Input characters
- ▼
- Step 2** Print

Prep 1 Install cassettes

Install the ribbon cassette and the tube attachment.

1 Open the cover.

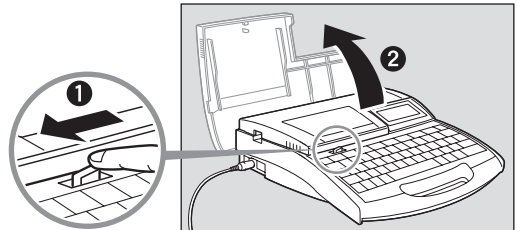

2 Take up any slack in the ribbon.

- Remove the stopper and then take up any slack in the ribbon.

Memo

The printer cannot detect the ribbon if it has any slack. Always be sure to take up slack in the ribbon when installing the ribbon cassette.

Memo

Dispose the removed stopper according to local government regulation.

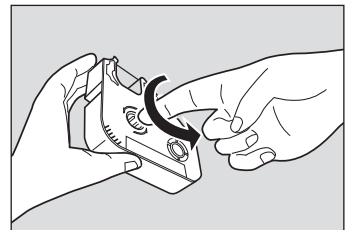
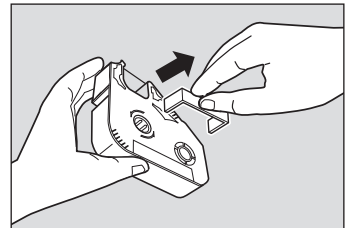

3 Install the ribbon cassette into the printer.

- Push the cassette in until it clicks into place.

Memo

If the ribbon cassette is loose, the ribbon may not be detected, so be sure to press it in until it clicks.

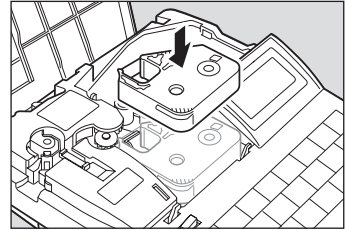
**CAUTION Do not touch the connector (metal part)**

Do not hold the connection terminal (metal part) of the cassette. Doing so could cause an improper recognition of the cassette.

4 Install the tube attachment into the printer.

- Align the tabs on the tube attachment with the holes in the printer, and then push the tube attachment in until it clicks into place.

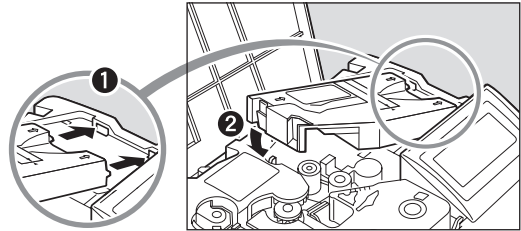
**5** Remove the wrap-around tape guide.

-  page 18.

6 Close the cover.

Close the cover completely so that it clicks shut.

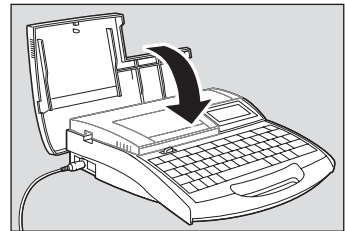
**Note****Two cassettes**

Two cassettes shown below are supplied with the printer.

Ink ribbon cassette

The ink ribbon cassette contains a ribbon that contains special ink. The ink is printed on a tube or label tape by applying heat to the ribbon.

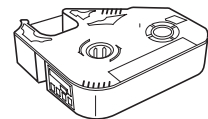
**Tube attachment**

The tube attachment is used to print characters on a tube. It feeds a tube into the printer.

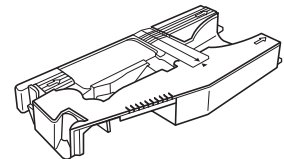

Prep 2 Insert tube

Tube is not provided with the printer; it must be purchased separately. The printer can print on tube with a diameter ranging from 2.5mm to 5.2mm. Note that the printer will not print properly on tube that is bumpy, dirty, or of uneven thickness.

1 Open the cover.

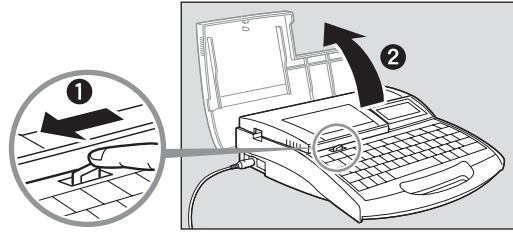

2 Insert a tube.

- Insert the tube into the intake, and push the tube in until it touches transport roller 2.

Memo

Insert the tube with the warp oriented as shown in the figure.

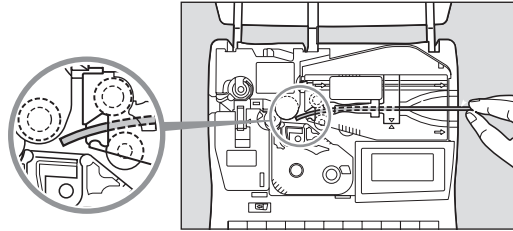
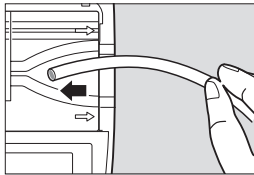

3 Close the cover.

Close the cover completely so that it clicks shut.

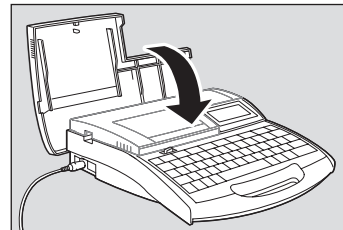

When tube presence cannot be detected

Depending on the type of tube, this machine may be unable to detect whether the tube is present. In such cases, use the clear tube mode for printing. However, in the clear tube mode, the machine cannot detect when the tube supply has run out.



When using a tube reel

Adjust the tube reel so that the load does not exceed 4.9N (500gf). If the load is too great, the tube will stretch and the cutting position will shift.

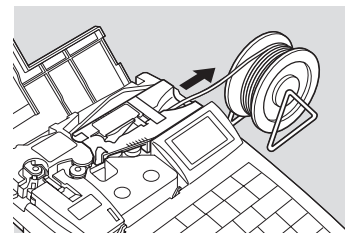

Prep 3 Turn the power switch on

Before turning the power switch on, make sure that the cassettes and tube have been inserted properly, that the cover is closed, and that the AC adapter is properly connected.

- 1** Press the “I” side of the power switch.

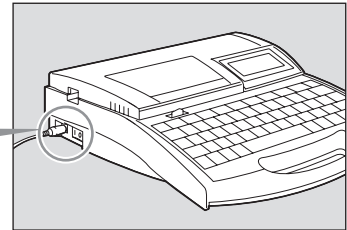

- The startup display appears.



Startup display

- Character input display appears after displaying the ribbon cassette information.

Memo

The character input display appears immediately if no ribbon cassette is installed.

* If the display remains blank, refer to “Troubleshooting” (page 109).

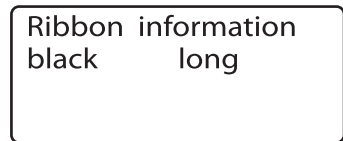

Ribbon cassette information display

important**Do not turn the power switch on and off rapidly**

Turning the power switch on and off rapidly and repeatedly can cause misoperation and the loss of stored data.

Step 1 Input characters

ex. Print four each of the following tube segments.



Tube to be used: ϕ 3.0mm

1 Input "200V"

Memo

To input uppercase letters or the characters appearing on the upper half of the keycaps, press and hold the [Shift] key, and then press the desired key.

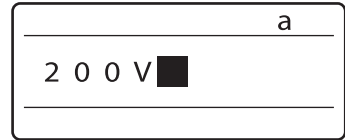

2 Press [Enter].

- A new page appears, and the system awaits input of more character data.

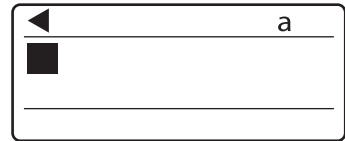

3 Input "Pump Room:"

If you input a wrong character
Press [Back Space] to delete the character and then
input the correct character.

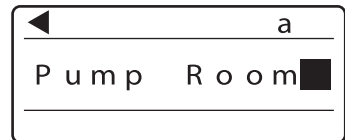

4 Press [Enter].

- A new page appears, and the system awaits input of more character data.

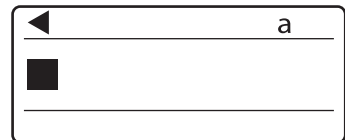

5 Input "A1:"

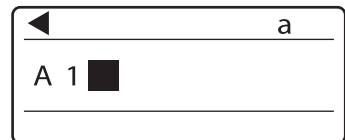



If you accidentally input an incorrect character

Follow the procedure described below to make changes if you accidentally input an incorrect character.

ex. You meant to input “200V” but accidentally input “240V”

1. Press [◀] or [▶] and move the cursor (■) to the “0”:

2. Press [Back Space] to delete the “4”:

3. Press “0” to input the correct character.



Deleting all entered text

Follow the procedure described below to delete all characters input on all pages.

1. Press [Delete].
 - The Delete display appears.

Memo

Even when all characters have been deleted, settings such as [Format] and [Style] are retained.

If two or more pages have been entered, the settings on the last page are retained.

2. Press [Enter].
 - All characters on all pages are deleted.



Number of characters that can be input

The printer can accept data input of totalling approximately 2500 characters on all pages combined; if the printer's capacity is exceeded, the message "Not enough memory Character input is no longer possible." appears. If this occurs, save all text data (refer to "Saving character data" on page 65), delete all characters that are displayed on the screen (refer to the Memo on the previous page, "Deleting all entered text"), and then continue inputting new characters.



What is a page?

As used in relation to the printer, the term "page" has special meaning. The text entries "200V", "Pump Room" and "A1" that were input in the procedure described on page 30 are actually input on three separate pages. A new page is created automatically whenever you enter characters and press [Enter].

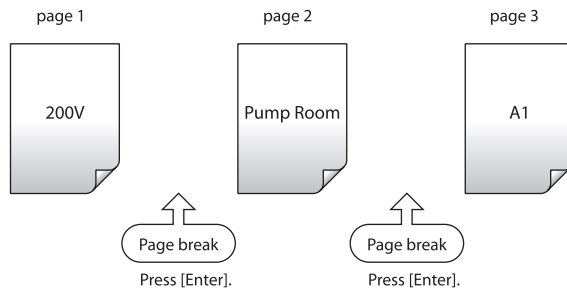

Viewing data from a previous page

If there is a page preceding the currently displayed page, "◀" appears in the upper left corner of the screen. If you press the [◀] key and move the cursor to the left past the first character that is currently displayed on the screen, the screen will change to show the character data from the preceding page. You can also jump directly to the preceding page by pressing [Shift] + [◀].

If there is a page that following the currently displayed page, "▶" appears in the upper right corner of the screen. If you press the [▶] key and move the cursor to the right past the last character that is currently displayed on the screen, the screen will change to show the character data from the next page. You can also jump directly to the next page by pressing [Shift] + [▶].

Indicates that there is a page preceding the current page.

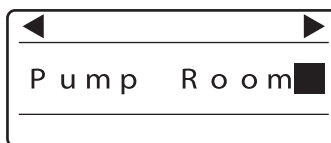

Indicates that there is a page following the current page.

Step 2 Print

Once the characters have been input, begin printing.

1 Press [Print/Print option].

- The print media selection display appears.

Memo

“No ribbon cassette” is displayed if the ribbon cassette is not installed. Install the ribbon cassette.

“No ribbon information. No ribbon amount displayed. Press enter” is displayed if the information cannot be read due to the ribbon cassette failure and so forth. If this message is displayed, follow the instruction on the screen.

Memo

What is “print media”?

Print media is the material that you are printing on, such as a tube, heat shrink tube, label tape, wrap around tape, 4mm I.D. strip, or clear tube.

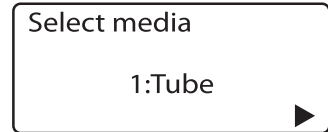
**2** Press [◀] or [▶] to select “1:Tube,” and then press [Enter].

- The tube size (inner diameter) selection display appears.

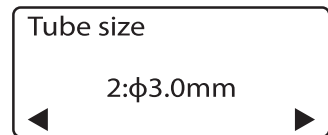
**3** Press [◀] or [▶] to select “2:φ3.0mm,” and then press [Enter].

Select the correct tube size

Printing will not be performed correctly if you do not select the correct tube size.

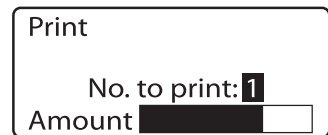

- The sets to print display appears.

Memo

Rough amount of the remaining ink ribbon is displayed as shown. When the information of the cassette is not properly retrieved, the amount of the ribbon does not appear.

4 Press [4] and [Enter].

- The result of this operation is that the character data for three pages is printed four times.

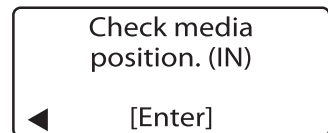
**5** Confirm the location of the leading end of the loaded tube, press [◀] or [▶] to select the appropriate input side, and press [Enter].**Memo**

If the leading end of the loaded tube is at the transport roller 2, select [IN], and if its at the cutter side, select [OUT].

If a wrong side is selected, media will be used wastefully.

Canceling printing

If you press [Cancel], the message “Aborting print” appears and printing is aborted. In this case, the tube that is currently being printed is cut and then ejected.

**6** Take out the tube.

- A half-cut tube is ejected.

If a tube jams

Hold down [Cancel] until the printer beeps. The printer stops all operations immediately. In this case, the tube is not cut and it is not ejected. Refer to “If a Tube or Label Tape Becomes Jammed” (page 90) and take out the jammed tube.

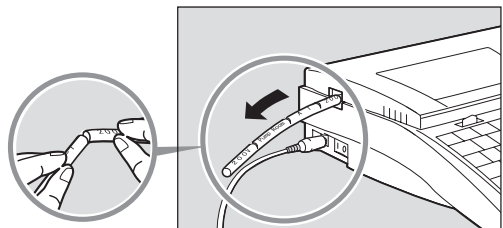

The tube is half-cut to permit easy cutting by hand.

2.2 Printing on Label Tape, Heat Shrink Tube, and 4mm I.D. Strip

Print the text by the following operating procedure. Prepare the following according to the type of media to be printed

- To print on label tape: label tape cassette
- To print on heat shrink tube: heat shrink tube cassette
- To print on 4mm I.D. strips: 4mm I.D. strip cassette

These cassettes are not include with the machine: they must be purchased separately. Contact your dealer for details.

Prep 1 Install cassettes



Prep 2 Turn the power switch on



Step 1 Input characters



Step 2 Print

Prep 1 Install cassettes

Install the ribbon cassette and the label tape cassette. Note that this explanation assumes that you will be printing on label tape. If you will be printing on heat shrink tube or 4mm I.D. strip, simply substitute heat shrink tube cassette or 4mm I.D. strip cassette for label tape cassette as appropriate.

1 Open the cover.

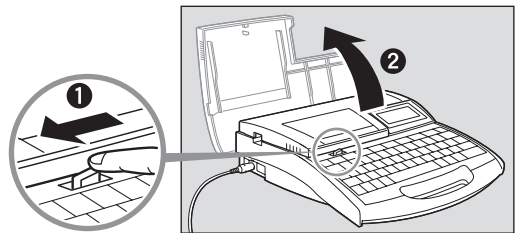

2 Take up any slack in the ribbon.

- Remove the stopper and then take up any slack in the ribbon.

Memo

The printer cannot detect the ribbon if it has any slack in the ribbon. Always be sure to take up slack in the ribbon when installing a cassette.

Memo

Dispose the removed stopper according to local government regulation.

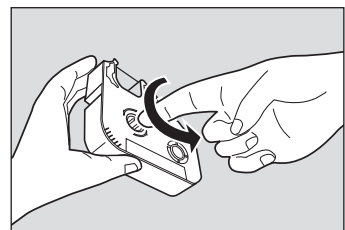
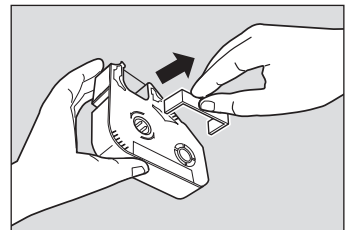

3 Install the ribbon cassette into the printer.

- Push the cassette in until it clicks into place.

Memo

If the ribbon cassette is loose, the ribbon may not be detected, so be sure to press it in until it clicks.

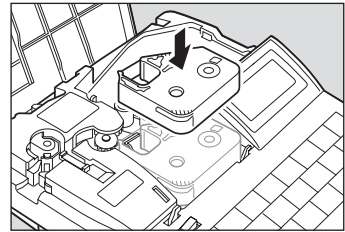
**CAUTION Do not touch the connector (metal part)**

Do not hold the connection terminal (metal part) of the cassette. Doing so could cause an improper recognition of the cassette.

4 Install the label tape cassette into the printer.

- Align the tab on the label tape cassette with the hole in the printer, and then push the cassette in until it clicks into place.

Memo

Confirm that the release paper is not peeled when setting the label cassette. Before setting, cut the part where the release paper is peeled or the end is not straight.

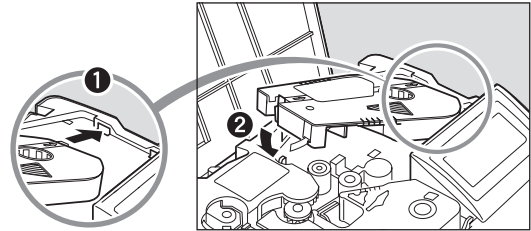
**5** Remove the wrap-around tape guide.

-  page 18.

6 Close the cover.

Close the cover completely so that it clicks shut.

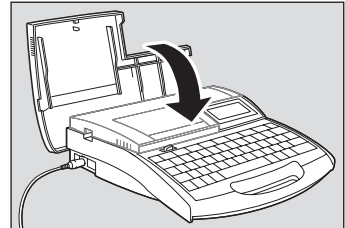
**Various cassettes**

These cassettes must be purchased separately. Contact your nearest dealer for details.

Label tape cassette

This is used to print characters on label tape.

Heat shrink tube cassette

This is used to print characters on heat shrink tube.

Wrap-around tape cassette

This is used to print on wrap-around tape.

4mm I.D. strip cassette

This is used to print characters on 4mm I.D. strip.

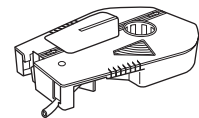

important

Do not install the wrong type of cassette

The printer can print on tube, clear tube, label tape, heat shrink tube, wrap around tape, and 4mm I.D. strip, but each requires a different type of cassette.

If a wrong type of cassette is installed, printing cannot be performed normally.

When printing on regular or clear tube

Install the ribbon cassette and tube attachment in the machine.

If the wrap-around tape guide or label tape cassette is already installed, remove it first. Note that the tube attachment does not come with tube; the tube must be purchased separately.

When printing on label tape, heat shrink tube or 4mm I.D. strip

Install the ribbon cassette and the appropriate cassette in the machine.

The wrap-around tape guide and tube attachment are not used, so if they are already installed, remove them first.

When printing on wrap-around tape

Install the ribbon cassette, the wrap-around tape cassette and wrap-around tape guide in the machine. The tube attachment is not used, so if it is already installed, remove it first.

Note

What to do if the label tape becomes stuck inside the cassette

Ordinarily, the tip of the label tape protrudes from the cassette as shown in Fig. 1, but sometimes the label tape becomes wound all the way into the cassette, as shown in Fig. 2.

In this case, pull the label tape out as shown in Fig. 3.

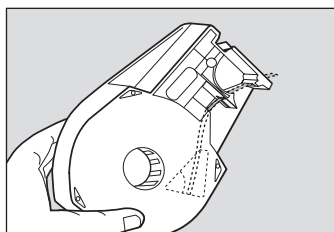

Fig. 1
The label tape should be set as shown here.

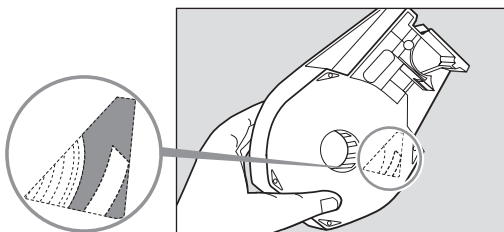

Fig. 2
Here, the label tape has become wound up inside of the cassette.

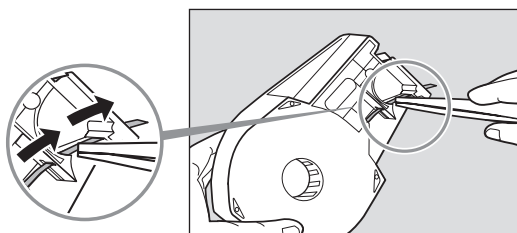
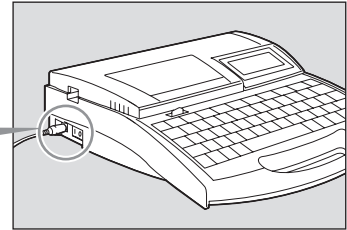

Fig. 3
Use tweezers to pull out the label tape to the prescribed position.

Prep 2 Turn the power switch on

Before turning the power switch on, make sure that the cassettes have been inserted properly, that the cover is closed, and that the AC adapter is properly connected.

- 1 Press the “I” side of the power switch.



- The startup display appears.

CABLE ID PRINTER **Mk1500**

Startup display

- Character input display appears after displaying the ribbon cassette information.

Memo

The character input display appears immediately if no ribbon cassette is installed.

* If the display remains blank, refer to “Troubleshooting” (📖 page 109).

Ribbon information
black long

Ribbon cassette information display

Important**Do not turn the power switch on and off rapidly**

Turning the power switch on and off rapidly and repeatedly can cause misoperation and the loss of stored data.

Step 1 Input characters

ex. Print the following label tape.

10W	+12V -12V	Relay
-----	--------------	-------

Label tape being used: 9mm label tape

Memo

Two-line printing is not performed properly when using label tape that is 6mm wide, heat shrink tube, or 4mm I.D. strip.

1 Input "10W".

Memo

If you accidentally input an incorrect character, press [Back Space] to delete the character and then input the correct one.



2 Press [Enter].

- A new page appears, and the system waits for input of more character data.

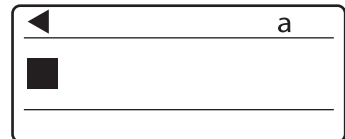

Indicates that another page precedes the currently displayed page.

3 Press [Style].

- Since the middle label has two lines press [Style] to change the Line setting.

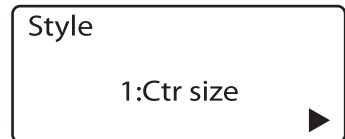

4 Press [◀] or [▶] to select "2:Line", and press [Enter].

- The Line setting display appears.

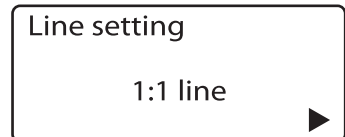

5 Press [◀] or [▶] to select "2:2 lines" and then press [Enter].

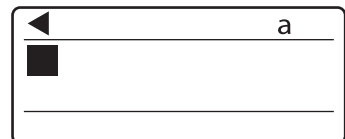

The input display now has two lines.

6 Input "+12V".

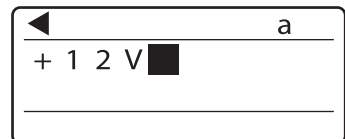

7 Press either [▼] or [▶].

Memo

If you press [Enter] instead of [▼] or [▶], a new page is created.

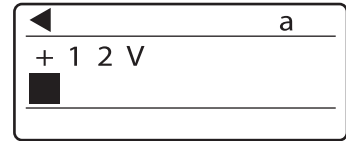

The cursor moves to the second line.

8 Input “-12V”.

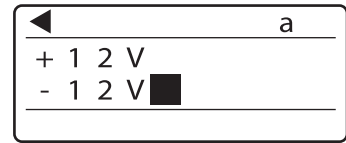

9 Press [Enter].

- A new page appears, and the system waits for input of more character data.

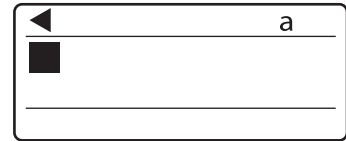

Indicates that another page precedes the currently displayed page.

10 Press [Style].

- Since the third label has just one line, press [Style] to change the Line setting for the third label.

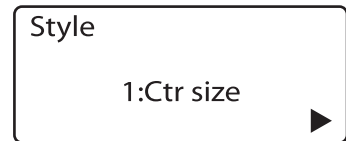

11 Press [◀] or [▶] to select “2:Line”, and press [Enter].

- The Line setting display appears.

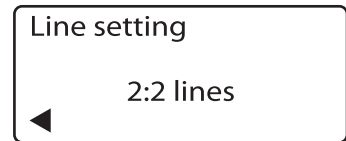

12 Press [◀] or [▶] to select “1:1 line” and then press [Enter].

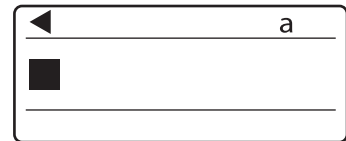

The input display now has one line.

13 Input “Relay”.

If you input the wrong character
Press [Back Space] to delete the character and then input the correct one.

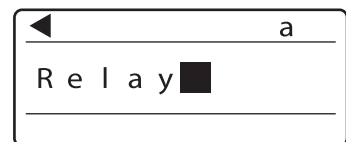



If you accidentally input an incorrect character

Follow the procedure described below to make changes if you accidentally input an incorrect character.

ex. You meant to input “-12V” but accidentally input “-32V”

1. Press [◀], [▶], [▲] or [▼] and move the cursor (■) to the “2”:

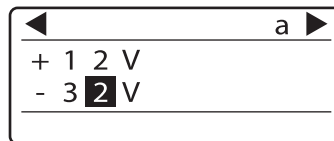

2. Press [Back Space] to delete the “3”:

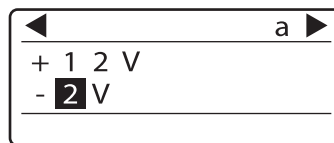

3. Press [1] to input the correct character.

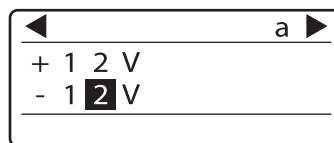

Deleting all entered text

Follow the procedure described below to delete all characters input on all pages.

1. Press [Delete].
 - The Delete display appears.

Memo

Even when all characters have been deleted, settings such as [Format] and [Style] are retained.

If two or more pages have been entered, the settings on the last page are retained.

2. Press [Enter].
 - All characters on all pages are deleted.

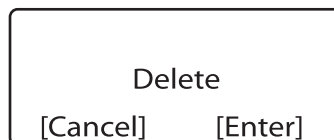

Step 2 Print

Once the characters have been input, begin printing.

1 Press [Print/Print option].

- The print media selection display appears.

Memo

“No ribbon cassette” is displayed if the ribbon cassette is not installed. Install the ribbon cassette.

“No ribbon information. No ribbon amount displayed. Press enter” is displayed if the information cannot be read due to the ribbon cassette failure and so forth. If this message is displayed, follow the instruction on the screen.

Memo

What is “print media”?

Print media is the material that you are printing on, such as a tube, heat shrink tube, label tape, wrap around tape, 4mm I.D. strip, or clear tube.

**2** Press [◀] or [▶] to select “4:Label”, and then press [Enter].

- The label tape size (width) selection display appears.

Memo

If 4mm I.D. strip is the selected media, the size display does not appear.

**3** Press [◀] or [▶] to select “2:9mm”, and then press [Enter].

- The sets to print display appears.

Memo

Rough amount of the remaining ink ribbon is displayed as shown. When the information of the cassette is not properly retrieved, the amount of the ribbon does not appear.

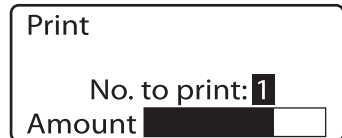
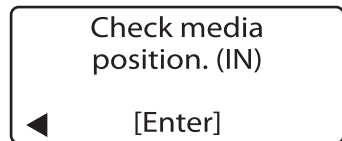
**4** Press [Enter].**5** Confirm the location of the leading end of the loaded label tape, press [◀] or [▶] to select the input side, and press [Enter].**Memo**

If the leading end of the loaded label tape is at the transport roller 2, select [IN], and if its at the cutter side, select [OUT].

Canceling printing

If you press [Cancel], the message “Aborting print” appears and printing is aborted. In this case, label tape that is currently being printed is cut and then ejected.

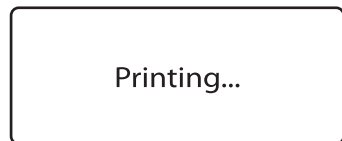
**6** Take out the label.

- A half-cut label is ejected.

If label tape jams

Hold down [Cancel] until the printer beeps. The printer stops all operations immediately. In this case, the label tape is not cut and it is not ejected. Refer to “If a Tube or Label Tape Becomes Jammed” (page 90) and take out the jammed label tape.

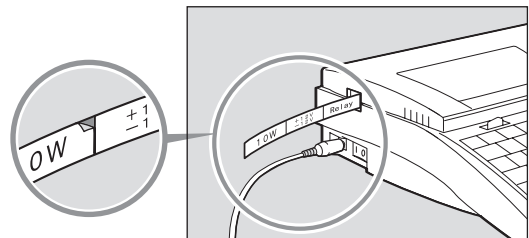

A small notch is cut between each label so that the labels can be easily separated.

2.3 Printing on Wrap-around Tape

Wrap-around tape consists of a printable part and a transparent laminate. It is used for indicating the destinations of cables.

Prepare a wrap-around tape cassette and print characters by the following procedure.

Note that a wrap-around tape cassette is not supplied with the machine; it must be purchased separately.

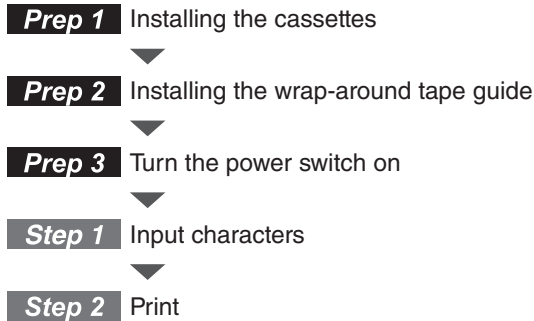

Prep 1 Installing the cassettes

Install a ribbon cassette and a wrap-around tape cassette.

1 Open the cover.

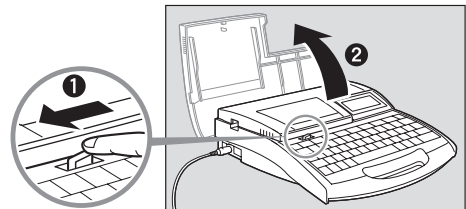

2 Take up any slack in the ribbon.

- Remove the stopper and then take up any slack in the ribbon.

Memo

The printer cannot detect the ribbon if it has any slack in the ribbon. Always be sure to take up slack in the ribbon when installing a cassette.

Memo

Dispose the removed stopper according to local government regulation.

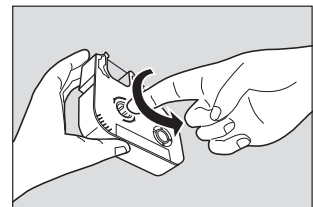
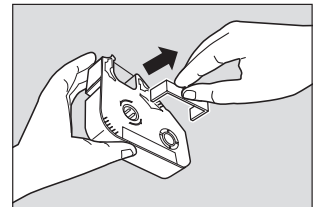

3 Install the ribbon cassette in the printer.

- Press it firmly so that it clicks into place.

Memo

If the ribbon cassette is loose, the ribbon may not be detected, so be sure to press it in until it clicks.

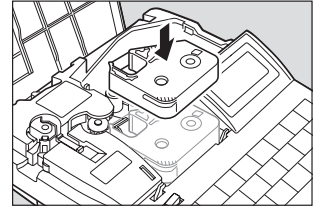

CAUTION Do not touch the connector (metal part)

Do not hold the connection terminal (metal part) of the cassette. Doing so could cause an improper recognition of the cassette.

4 Install the wrap-around tape cassette into the printer.

- Align the tab on the wrap-around tape cassette with the hole in the printer, and then push the cassette in until it clicks into place.

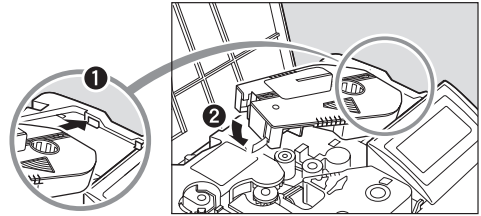

Prep 2 Installing the wrap-around tape guide

Install the wrap-around tape guide

Memo

If the wrap-around tape guide has been installed, verify that it is installed correctly.

1 Pull out the cutter.

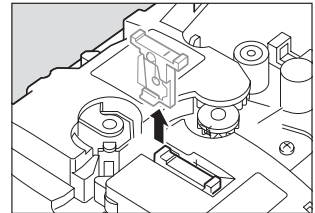

2 Install the wrap-around tape guide.

- Press the guide firmly so that it hooks under the ledge in the machine.

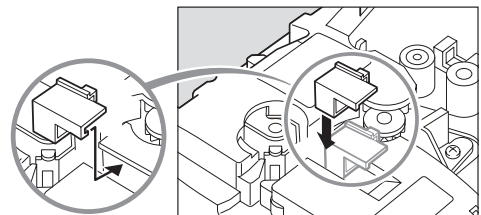

3 Install the cutter.

- To ensure correct orientation, align the “-” mark on the cutter with the “◀” mark as shown, and insert the cutter all the way in.

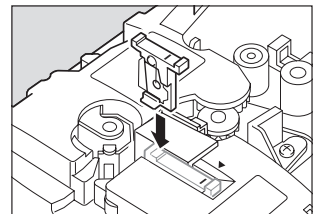

4 Close the cover.

Close the cover completely so that it clicks shut.

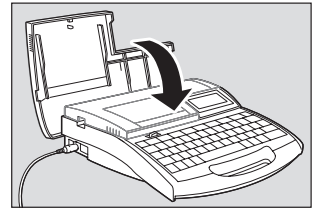

Prep 3 Turn the power switch on

Before turning the power switch on, make sure that the cassettes are inserted correctly, that the cover is closed, and that the AC adapter is connected properly.

1 Press the “I” side of the power switch.

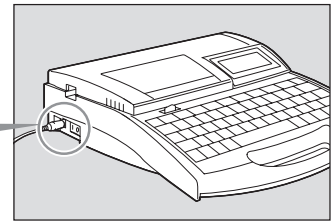

- The startup display appears.



Startup display

- Character input display appears after displaying the ribbon cassette information.

Memo

The character input display appears immediately if no ribbon cassette is installed.

* If the display remains blank, refer to “Troubleshooting” (page 109).

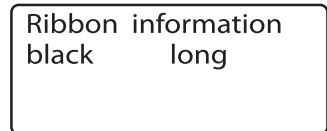

Ribbon cassette information display

Important

Do not turn the power switch on and off rapidly

Turning the power switch on and off rapidly and repeatedly can cause misoperation and the loss of stored data.

Step 1 Input characters

ex. create three pieces of wrap-around tape of the following types.



- 1** Press [Caps Lock] to activate upper-case input mode.

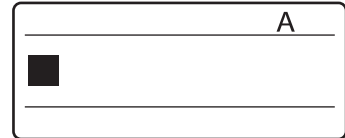

- 2** Input "A-1".

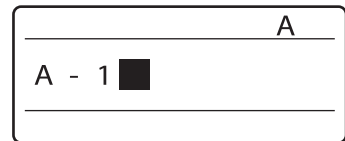

Note

If you accidentally entered the wrong character

If you make a mistake when entering characters, correct it as follows.

ex. If you entered "A=1" instead of "A-1".

- 1.** Press [◀], [▶] to move the cursor (■) to the "1".



- 2.** Press [Back Space] to delete the "=".

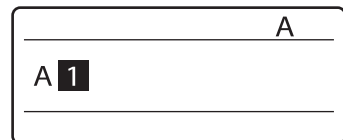

- 3.** Press [-] to enter the correct character.

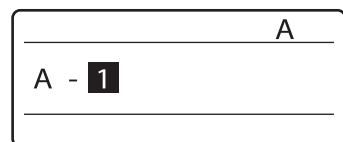



Note

Deleting all entered text

Follow the procedure described below to delete all characters input on all pages.

1. Press [Delete].
 - The Delete display appears.

Memo

Even when all characters have been deleted, settings such as [Format] and [Style] are retained.

If two or more pages have been entered, the settings on the last page are retained.

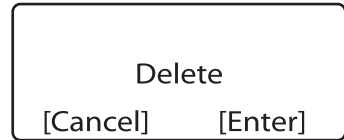

2. Press [Enter].
 - All characters on all pages are deleted.

Step 2 Print

Once the characters have been input, begin printing.

1 Press [Print/Print option].

- The print media selection display appears.

Memo

“No ribbon cassette” is displayed if the ribbon cassette is not installed. Install the ribbon cassette.

“No ribbon information. No ribbon amount displayed. Press enter” is displayed if the information cannot be read due to the ribbon cassette failure and so forth. If this message is displayed, follow the instruction on the screen.

Memo

What is “Print media”?

Print media is the material that you are printing on, such as a tube, heat shrink tube, label tape, wrap around tape, 4mm I.D. strip, or clear tube.

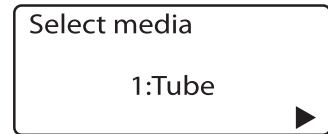
**2** Press [◀] or [▶] to select “6: Wrap-around”, and press [Enter].

- The print quantity selection display appears.

Memo

Rough amount of the remaining ink ribbon is displayed as shown. When the information of the cassette is not properly retrieved, the amount of the ribbon does not appear.

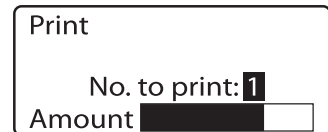
**3** Press [3] and then [Enter].

- Three pieces are printed.

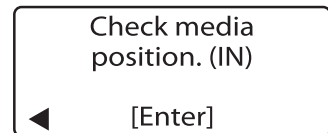
**4** Confirm the position of the leading end of the wrap-around tape, press [◀] or [▶] to select the input side, and press [Enter].**Memo**

If the leading end of the loaded tape is at the transport roller 2, select [IN], and if its at the cutter side, select [OUT].

Canceling printing

If you press [Cancel], the message “Aborting print” appears and printing is aborted. In this case, the tape that is currently being printed is cut and then ejected.

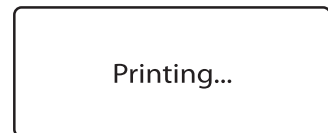
**5** Take out the wrap-around tape.

- A half-cut tape is ejected.

If tape jams

Hold down [Cancel] until the printer beeps. The printer stops all operations immediately. In this case, the tape is not cut and it is not ejected. Refer to “If a Tube or Label Tape Becomes Jammed” (page 90) and take out the jammed tape.

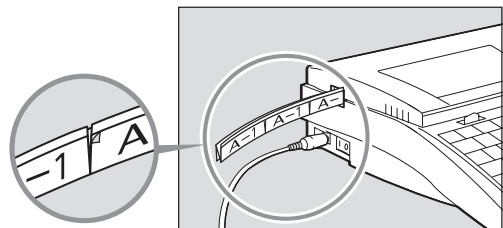

The tape is half-cut so that it can be easily separated by hand.



Attaching the wrap-around tape

1. Peel the printed film from the wrap-around tape backing.

Memo

When wrapping, the laminating cover should overlap the printed part sufficiently. We therefore recommend using with cable of $\phi 3$ to $\phi 7.6$ mm.



2. Attach the tape to the cable as shown in the diagram, starting from the printed end.

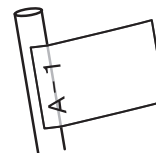

3. Wrap the transparent laminating portion so that it covers the printed part.



If the film does not peel away from the backing

Because wrap-around tape has a strong adhesive, it may be hard to peel the film off the backing. Refer to the following diagram for the peeling method.

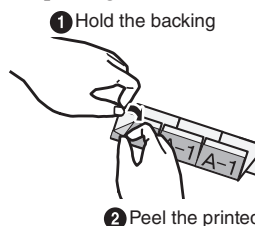
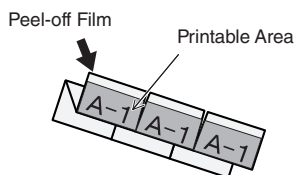

If the cut is too shallow

Wrap-around tape is thicker than typical label tape, so the half-cut may be shallower.

In this case, refer to “What To Do If the Cutter Is Getting Blunt” on page 96 to adjust cutting depth. If it still does not cut, replace with new cutter. (📄 page 98)

Memo

If the half-cut is too shallow, the film may not peel from the backing properly.

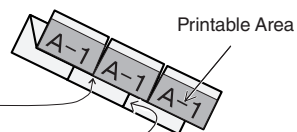

If this part is joined, pull apart with your fingers

If the remaining part cannot be separated, adjust the cutting depth.



Nisca Corporation shall not be responsible for damages that might result from the tape peeling off, or from fading of the printing on the tape.

Part 3

Character Input

This section explains how to input characters and symbols, and how to delete and change characters.

3.1	<i>Inputting Characters</i>	50
	Inputting characters	50
3.2	<i>Inputting Symbols</i>	51
	Inputting symbols	51
3.3	<i>Deleting Characters, Creating New Pages, Moving the Cursor</i>	52
	Deleting or changing characters	52
	Deleting all entered text data	53
	Creating a new page.....	53
	Inserting a page.....	54
	Deleting a page.....	54
	Moving the cursor	55

3.1 Inputting Characters

■ Inputting characters

Input the following characters:

ex. Res 7-1

1 Input “Res 7-1”

Memo

To input uppercase letters or the characters appearing on the upper half of the keycaps, press and hold the [Shift] key, and then press the desired key.

If you input an incorrect character

Press [Back Space] to delete the character and then input the correct one.

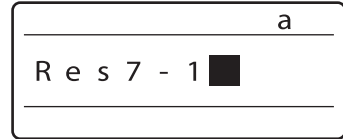

Note

To input uppercase letters only

If you only want to input uppercase characters (for example, “SYSTEM”), it is more convenient to press the [Caps Lock] key than type while holding down the [Shift] key.

When you press the [Caps Lock] key, letters are input as uppercase letters and the system is set to “Caps Lock input mode.” If you want to input a lowercase letter while in Caps Lock input mode, simply type it while holding down the [Shift] key.

3.2 Inputting Symbols

Inputting symbols

Input the following characters:

ex. 250Ω

1 Input “250”

If you input an incorrect character

Press [Back Space] to delete the character and then input the correct one.



2 Press [Symbol].

- The symbol selection display appears.

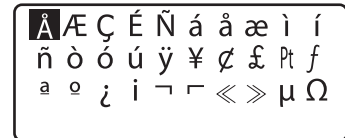

3 Press [◀], [▶], [▲], or [▼] to select “Ω”

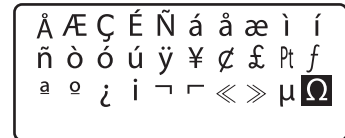

4 Press [Enter].

- This inputs the symbol “Ω”.

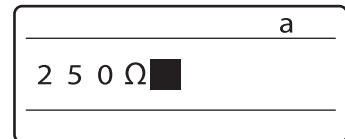

3.3 *Deleting Characters, Creating New Pages, Moving the Cursor*

■ Deleting or changing characters

ex. Change “-1750V” to “-1720V”

- 1 Move the cursor to the “0”.
 - Press [◀] or [▶] to move the cursor.

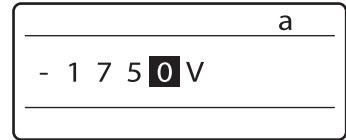

- 2 Press the [Back Space] key to delete the “5”.
 - The [Back Space] key deletes the character that is located to the left of the cursor.

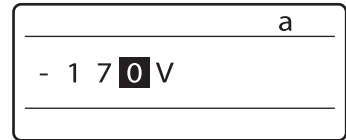

- 3 Press [2].

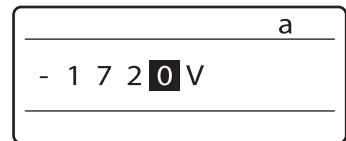

Deleting all entered text data

Follow the procedure described below to delete all characters input on all pages.

1 Press [Delete].

- The Delete display appears.

Memo

Even when all characters have been deleted, settings such as [Format] and [Style] are retained.

If two or more pages have been entered, the settings on the last page are retained.

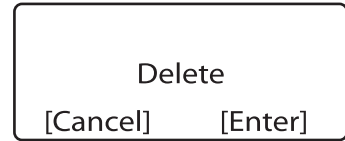

2 Press [Enter].

- All characters on all pages are deleted.

Creating a new page

In order to print three tube segments as shown below, a total of three pages of character data must be created. This is accomplished by creating a page break between each page of text data. When a page break is created, a new page is created automatically.

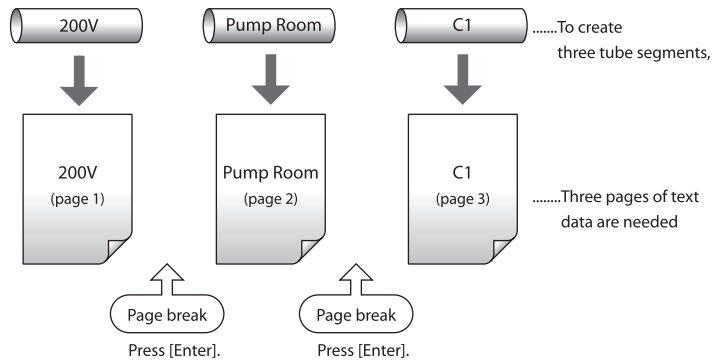

Inserting a page

You can insert a blank page.

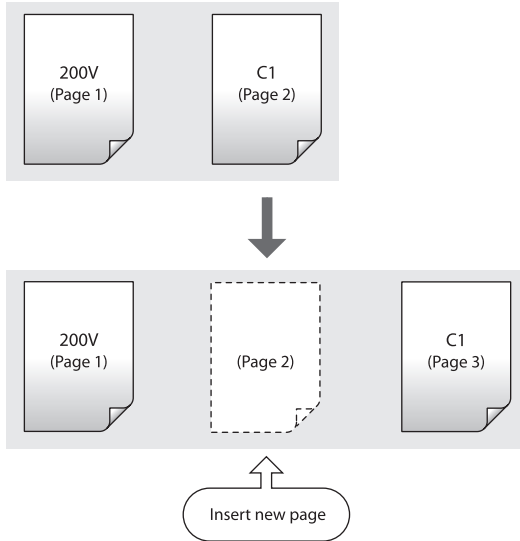

To insert a new page between the first and second pages, move the cursor to the end of the text on the first page, and press [Shift] + [Enter]. A new page is created between the first and second pages, and the input display for the new page appears.

Memo

Settings such as [Format] and [Style] for the new page are the same as those of the previous page.

Deleting a page

You can delete a specified page.

After pressing [Back Space] to delete all characters on the page to be deleted, press [Shift] + [Back Space].

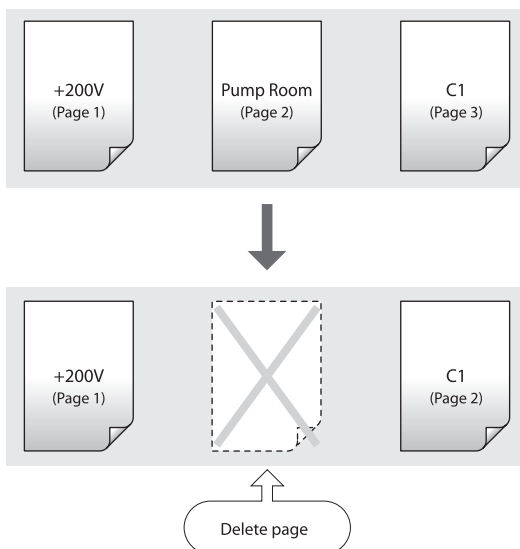

■ Moving the cursor

The cursor can be moved to the previous and to the next page.

Moving to the previous page

- Press [Shift] + [◀].



The cursor moves to the top of the previous page.

Moving to the next page

- Press [Shift] + [▶].



The cursor moves to the top of the next page.

Part 4

Advanced Operations

This chapter describes how to change characters and the number of lines, saving character data and various printing operations.

4.1	<i>Changing the Characters and the Number of Lines</i>	58
	Changing character size	58
	Changing the spacing between characters.....	59
	Adding an underline to “6” and “9”.....	60
	Adding a frame to characters.....	61
	Printing on two lines.....	62
4.2	<i>Saving, Retrieving and Deleting Character Data....</i>	64
	Files	64
	Saving character data	65
	Loading character data	66
	Deleting character data.....	67
4.3	<i>Various Printing Functions... </i>	68
	Printing count.....	68
	Changing the printing orientation.....	70
	Changing the length and the character alignment.....	72
	Printing a specific page multiple times (Continuous Print)	74
	Generating sequential characters (serial printing)	76
	Adjusting the printing start position and vertical position	79
	Adjusting the printing density.....	81
4.4	<i>Changing the Cutting Method.....</i>	82
	Half cuts and full cuts.....	82
	Turning off half cuts.....	82
4.5	<i>Other Operations</i>	84
	Removing the print media.....	84
	Changing the display contrast.....	86
	Restoring the initial settings	87
	Increasing the printing speed.....	88

4.1 Changing the Characters and the Number of Lines

This section explains various character and line-related functions, such as changing the size of printed characters, widening the spacing between characters, and printing on two lines.

■ Changing character size

It is possible to change the size and width of printed characters. There are six choices available for the size and width of printed characters. Initially, “3mm 100%” is selected.

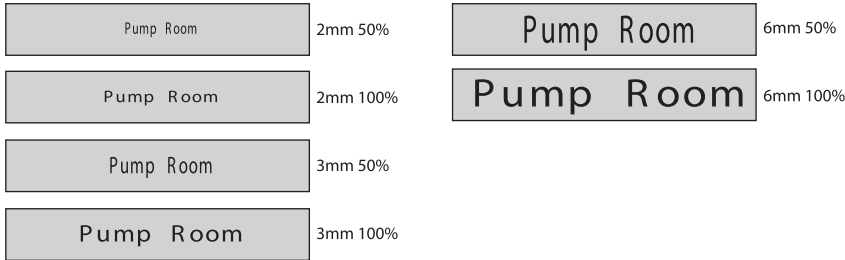

Memo

The size of printed characters can be changed for individual pages.

ex. Select “3mm 50%” as the character size.

1 Input the characters.

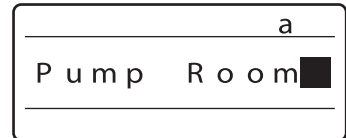

2 Press [Style].

- The setting display appears.

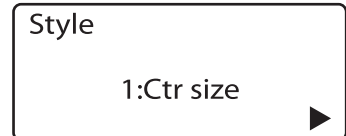

3 Press [◀] or [▶] to select “1:Ctr size,” and press [Enter].

- The Character Size selection display appears.

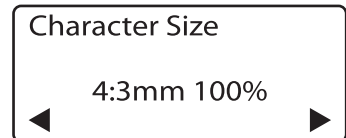

4 Press [◀] or [▶] to select “3:3mm 50%,” and then press a [Enter].

- The display returns to the character input display; you can now begin printing with the new size.

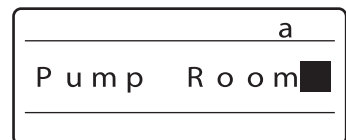

Character sizes that cannot be selected (printed)

- If “2 lines” is selected, the “6mm” character size cannot be selected.
- If the cut length is specified by the user, some character sizes might not be available, depending on the text data that is input.

■ Changing the spacing between characters

The spacing between printed characters can be changed as desired. There are three possible spacings of printed characters, as shown below. Initially, “Narrow” is selected.

Pump Room Narrow : No extra space between characters

P u m p R o o m Medium : 0.5mm between characters

P u m p R o o m Wide: 1.0mm between characters



Spacing for horizontal printing



Spacing for vertical printing

Memo

The spacing between printed characters can be changed for individual pages.

ex. set the spacing between characters to “Wide”

1 Input the characters.



2 Press [Style] and [◀] or [▶] to select “3:Ctr spacing,” then press [Enter].

- The Character Spacing selection display appears.

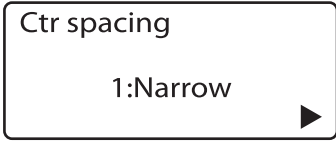

3 Press [◀] or [▶] to select “3:Wide,” and then press a [Enter].

- The display returns to the character input display; you can now begin printing with the new spacing.



 **Note** **Character spacings that cannot be selected (printed)**

- If the segment length is specified by the user, some character spacings might not be available, depending on the text data that is input.

■ Adding an underline to “6” and “9”

In order to make it easier to distinguish sixes and nines, both characters can be printed with an underline. Initially, the printer prints sixes and nines without an underline.

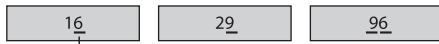

Underline is printed

Memo

This function cannot be changed for individual pages.

1 Input the characters.

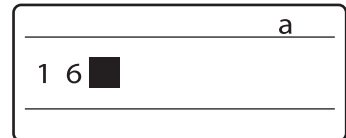

2 Press [Option].

- The setting display appears.

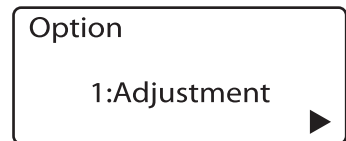

3 Press [◀] or [▶] to select “2:Print Option”, and press [Enter].

- The setting display appears.

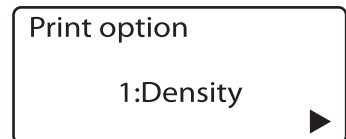

4 Press [◀] or [▶] to select “3:6, 9 underline”, and then 6, 9 underline press [Enter].

- The “6, 9 underline” selection display appears.

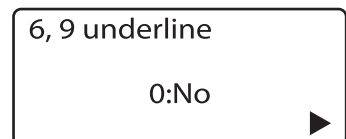

5 Press [◀] or [▶] to select “1:Yes”, and then press [Enter].

- The display returns to the character input display; you can now begin printing with the new setting.

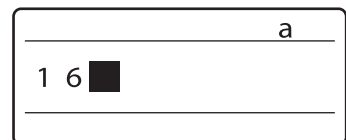

■ Adding a frame to characters

Text can be surrounded by frames. Initially, frames are disabled.

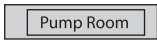

Memo

Text frames can be set independently for each page.

1 Input the characters.



2 Press [Format].

- The setting display appears.

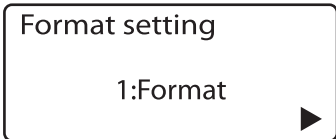

3 Press [◀] or [▶] to select "2:Enframe", and then press Enframe [Enter].

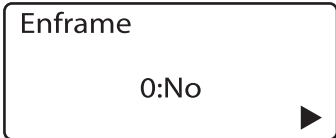

4 Press [◀] or [▶] to select "1:Yes", and then press [Enter].

- The display returns to the character input display; you can now begin printing with the frame.



 **Note** **Frames when using two-line printing**

Depending on character size, segment length, and so forth, frames may not print correctly around text that is printed on two lines. Furthermore, frames may not print correctly around large-size characters, even when printing on just one line.

■ Printing on two lines

It is possible to print on two lines as shown below. Initially, the printer is set to print on one line.

Memo

The number of lines to be printed can be changed for individual pages.

ex. Create the following labels:

Two-line printing

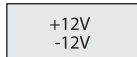

One-line printing



1 Press [Style].

- The setting display appears.

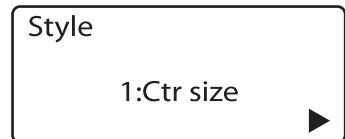

2 Press [◀] or [▶] to select "2:Line" and press [Enter].

- The Line setting display appears.

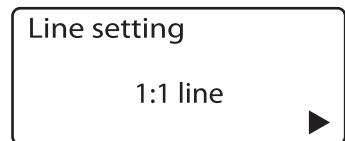

3 Press [◀] or [▶] to select "2:2 lines", and then press a [Enter].

- The character input display changes to two lines.

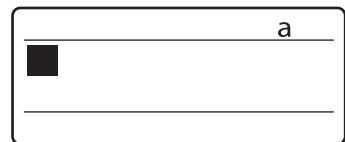

4 Input "+12V".

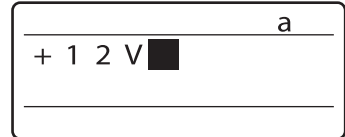

The characters are input on the first line.

5 Press [▼] or [▶].

Memo

If you press [Enter] instead of [▼] or [▶], a new page is created.

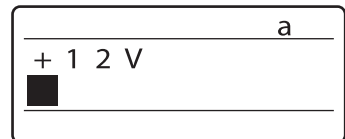

The cursor moves to the second line.

6 Input "-12V".

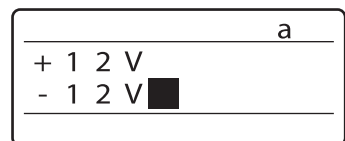

7 Press [Enter].

- A new page is created, and the printer waits for the next character to be input.

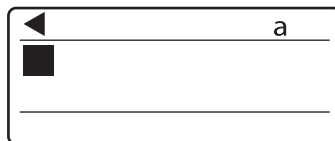

Indicates that another page precedes the currently displayed page.

8 Press [Style].

- The setting display appears.

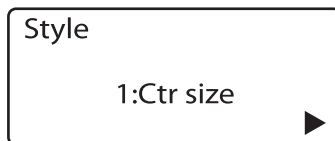

9 Press [◀] or [▶] to select “2:Line” and press [Enter].

- Since the second label has only one line, you must press [Style] again.

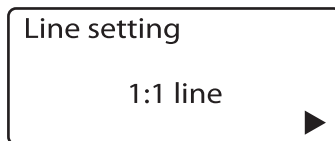

10 Press [◀] or [▶] to select “1:1 line,” and then press [Enter].

- The character input display changes to one line.

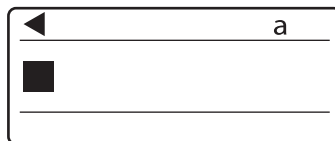

11 Input “Relay”:

- “Relay” is input, and you are now ready to print.

If you accidentally input an incorrect character, press [Back Space] to delete the character and then input the correct one.



Switching from two lines to one

After entering characters on two lines, you cannot switch from two lines to one without first deleting all characters on the second line. Only then can you switch the number of lines to one.



Using two-line printing when printing on tube, heat shrink tube or 4mm I.D. strip can result in part of the printing being missing or in incorrect printing. Correct printing may also be impossible with some character sizes.

4.2 Saving, Retrieving and Deleting Character Data

Files

You can save text as files in the machine's internal memory. To save text as a file, you need to give it a name.

You can also delete saved files.

Up to 20 files can be saved.

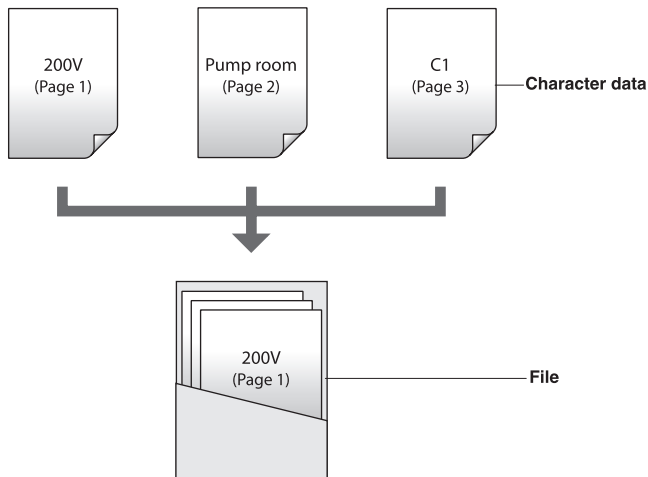

Important

To avoid losing saved data

An internal memory backup battery retains stored data. If the message at the right appears, contact your dealer immediately.

Memory backup
battery low

Contact dealer.

■ Saving character data

Character data that has been created can be stored in files.

Memo

A total of approximately 7,500 characters of character data can be saved. For example, if you have already saved a file containing 50 characters, an additional 7,450 characters can be saved.

ex. Save the character data that has been created in a file named “Switch 1”

1 Press [Regist.].

- The file registration checking display appears.

Regist.

Now checking...

2 Press [◀] or [▶] to select “1:New,” and then press Input file name a [Enter].

- The file name input display appears.

Input file name a



Memo

File names may contain up to 8 characters.

3 Input “Switch 1”

- If you accidentally input an incorrect character, press [Back Space] to delete it and then input the correct character.

Input file name a

Switch 1 ■

4 Press [Enter].

- After the display at right appears, the display returns to the character input display.

Now Saving...



important

Do not turn off the power when “Now Saving...” is displayed

Turning off the power while a file is being saved can damage the data.



Note

Up to 20 files can be saved

You can save up to 20 files. If you attempt to save more, “Already 20 files !” appears.



Note

Overwriting

If you attempt to save a file with the same name as a file that already exists, “Same file name exists. Overwrite?” appears. Select [Enter] if you want to overwrite, or select [Cancel] to save with a different name.

Loading character data

There are two methods for retrieving character data that has been stored in files: “New” and “Add”.

Loading with “New”

When character data (file) is retrieved, the character data that is currently displayed is deleted and is replaced with the retrieved character data.

Loading with “Add”

When the character data (file) is loaded, it is added following the last page of the data that is currently displayed.

ex. Add the text saved in the file named “Switch 1” to the currently displayed text.

1 Press [Regist.].

- The file registration checking display appears.

A rectangular display box with a black border. The text 'Regist.' is at the top, and 'Now checking...' is centered below it.

2 Press [◀] or [▶] to select “2:Find”, and then press Find mode [Enter].

A rectangular display box with a black border. The text 'Find mode' is at the top, and '1:New' is centered below it. A right-pointing arrow is at the bottom right corner.

3 Press [◀] or [▶] to select “2:Add”, and then press [Enter].

- The Choose file display appears.

Memo

If no files have been saved, the message “No files.” appears, and then the display returns to the character input display.

“**” appears next to the names of files that cannot be loaded because of their data size.

A rectangular display box with a black border. The text 'Choose file name' is at the top, and 'Switch 1' is centered below it. A right-pointing arrow is at the bottom right corner.

4 Press [◀] or [▶] to select “Switch 1”, and then press [Enter].

- The “Add” loading confirmation display appears.

A rectangular display box with a black border. The text 'Add registered doc!' is centered.

5 Press [Enter].

- After the display at right appears, the last page of the loaded character data is displayed.

A rectangular display box with a black border. The text 'Now searching...' is centered.

■ Deleting character data

It is possible to delete character data files that have been saved. There are two different modes for deleting files: “File”, and “All data”.

File

Deletes a single file.

All data

Deletes all files

ex. Delete the file named “Switch 1”

1 Press [Regist.].

- The file registration checking display appears.

Regist.
Now checking...

2 Press [◀] or [▶] to select “3:Delete,” and then press Delete mode [Enter].

- The deletion selection display appears.

Memo

If no files have been saved, the message “No files.” appears, and then the display returns to the character input display.

Delete mode
1:File ▶

3 Press [◀] or [▶] to select “1:File,” and then press [Enter].

- The Choose file display appears.

Memo

When you select “All data”, “Delete all data?” appears. Press [Enter].

Choose file name
Switch 1 ▶

4 Press [◀] or [▶] to select “Switch 1,” and then press [Enter].

- The deletion confirmation display appears.

Delete data
Switch 1 ?

5 Press [Enter].

- After the display at right appears, the display returns to the character input display.

Now deleting...

4.3 Various Printing Functions

■ Printing count

The number of pieces to print can be specified from 1 to 10. For example, if the following text has been entered to create three tubes.

Memo

Up to ten pieces of tube can be printed.

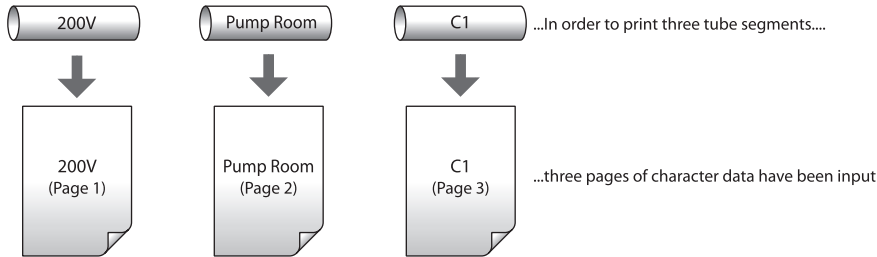

ex. Print three tube segments (Φ3.0 mm).

If “3” is set as the sets to print, tube segments are printed as shown below. In short, the three pages of character data are printed three times, resulting in a total of nine tube segments.

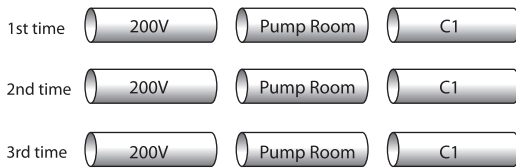

- 1** Press [Print/Print Option].
 - The Select media display appears.

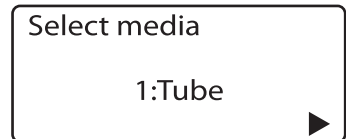

- 2** Press [◀] or [▶] to select “1:Tube”, and then press Tube size [Enter].
 - The Tube size selection display appears.

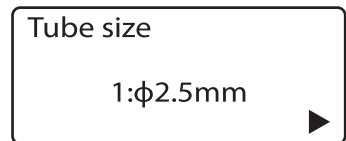

- 3** Press [◀] or [▶] to select “2:Φ3.0mm”, and then press Print [Enter].
 - The Sets to print setting display appears.

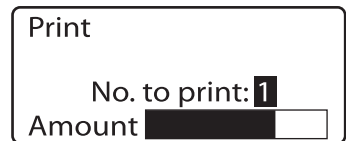

- 4** Press [3] and [Enter].
 - The result of this operation is that the character data for three pages is printed three times.

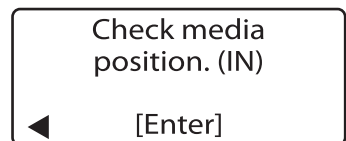

- 5** Confirm the location of the leading end of the loaded tube, press [◀] or [▶] to select the appropriate input side, and press [Enter].

Memo

If the leading end of the loaded tube is at the transport roller 2, select [IN], and if its at the cutter side, select [OUT].

Canceling printing

If you press [Cancel], the message “Aborting print” appears and printing is aborted. In this case, the tube that is currently being printed is cut and then ejected.

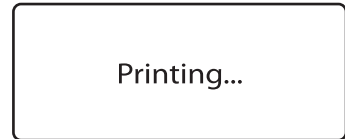

Changing the printing orientation

It is possible to change the printing orientation in order to produce output such as that shown below.

Memo

The printing orientation of each page can be changed.

Horizontal Character   

Vertical Character   

ex. Print label tape (12mm wide) as shown below.

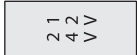

- 1** Press [Format].
 - The function selection display appears.
- 2** Press [◀] or [▶] to select “1: Format”, and press [Enter].
 - The Orientation display appears.
- 3** Press [◀] or [▶] to select “2:Vertical”, and then press a [Enter].
 - The character input display appears.
- 4** Press [Style].
 - This is because you are going to input two lines.
- 5** Press [◀] or [▶] to select “2:Line”, and press [Enter]
 - The Line setting display appears.
- 6** Press [◀] or [▶] to select “2:2 lines”, and then press a [Enter].
 - The character input display now shows two lines.
- 7** Input “12V”:

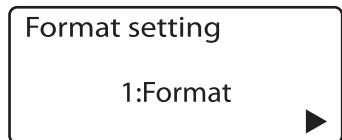
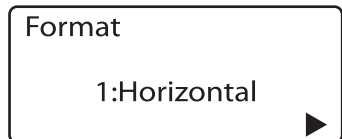
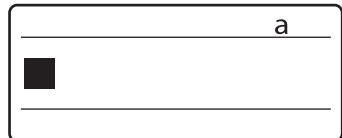
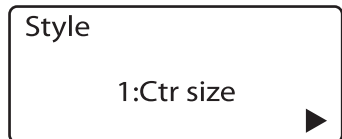
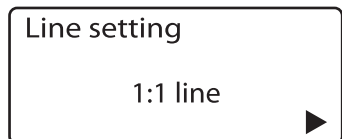
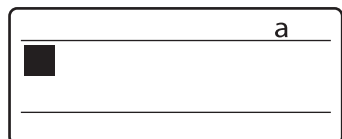
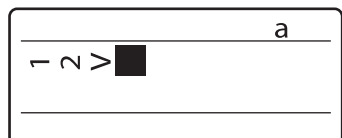





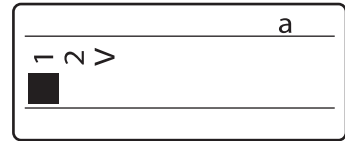

Confirm that the characters that are input are displayed on their side.

8 Press [▼] or [▶].

Memo

If you press [Enter] instead of [▼] or [▶], a new page is created.



9 Input "24V".

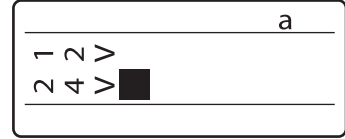

10 Press [Print/Print Option].

- The Select media display appears.

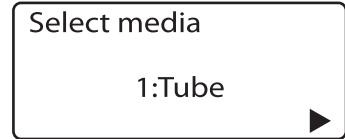

11 Press [◀] or [▶] to select "4:Label", and then press Label size [Enter].

- The label tape size (width) selection display appears.



12 Press [◀] or [▶] to select "3:12mm", and then press Print [Enter].

- The sets to print display appears.

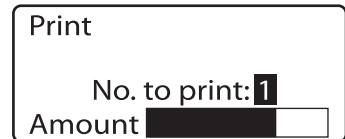

13 Press [Enter].

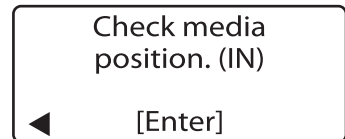

14 Confirm the location of the leading end of the loaded label tape, press [◀] or [▶] to select the input side, and press [Enter].

Memo

If the leading end of the loaded label tape is at the transport roller 2, select [IN], and if its at the cutter side, select [OUT].

Canceling printing

If you press [Cancel], the message "Aborting print" appears and printing is aborted. In this case, label tape that is currently being printed is cut and then ejected.

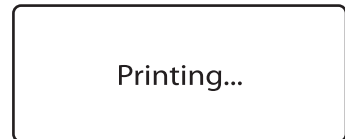

Printing might not be performed correctly in some orientations, depending on the settings for the media size and the character size.

Changing the length and the character alignment

After each tube or tape is printed, it is output in a “Half cut” condition*. The length between half cuts is called the “segment length”. There are two modes for setting the segment length: “Automatic” and “Specify”. Furthermore, the positioning of characters printed on a tube or tape is called the “Alignment”.

There are two settings: “Centered” and “Left”.

* Initial setting

Memo

The segment (cutting) length and character position can be set independently for each page.

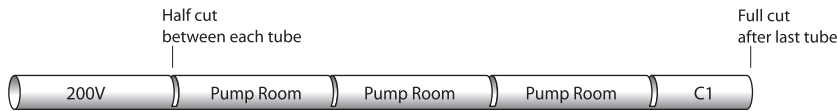

Automatic

The optimal segment length is selected automatically, based on the number of characters input, the size of the characters, and the character spacing. The character alignment is “centered”. “Automatic” is the initial setting.

Because the length of each tube is determined automatically on the basis of the number of characters, the size of the characters, and the spacing between each character, tube segments will be of different lengths if they have different numbers of characters.

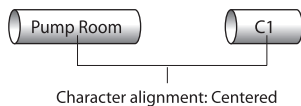

Specify

The segment length is specified by the user. The segment length can be specified in steps of 1 mm within the range of 8 mm to 150 mm. If “Automatic” is set and one tube is produced with four characters while another is produced with two characters, the tube with two characters will be shorter. (Refer to the diagram above.) In this situation, you can have the two-character tube and the four-character tube cut to the same length by selecting “Specify” and then setting the four-character tube segment length. The character alignment can be selected as either “Centered” or “Left”.

If the segment length is specified, the tube length is always the same, regardless of whether two or four characters are printed.

• Character alignment: Centered



• Character alignment: Left

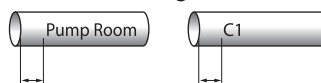

When “Left” is selected, the margin between the left edge and the first character must be specified.

Note

Depending on print media characteristics and the environment in which the printer is being used, the segment length and the margins may vary slightly from the set values. The settings should only be considered as guidelines. The characteristics of tube in particular can cause significant variances. For details on how to make adjustments for these variances, refer to “Adjusting the printing start position and vertical position” (page 79).

ex. Print the following character data with the segment length set to 50mm, “Left” set for the character alignment, and a margin of 5mm.

Character data



Final output

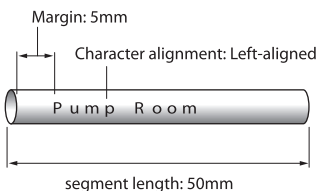

1 Press [Length/Margin].

- The Set length display appears.

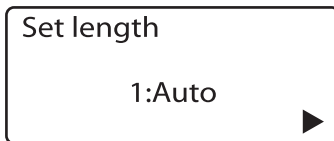

2 Press [◀] or [▶] to select “2:Specify”, and then press Specify [Enter].

- The segment length input display appears.



Memo

Segment length can be set from 8 to 150 mm.

3 Enter “50” for the segment length, and press [Enter].

- The character alignment selection display appears.

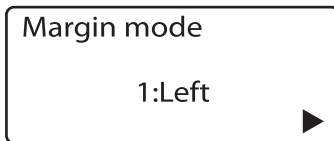

4 Press [◀] or [▶] to select “1:Left”, and then Press [Enter].

- The margin setting input display appears.

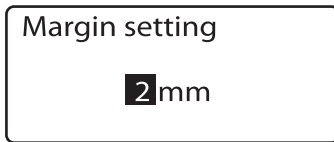

Memo

The margin can be set from 2 to 5 mm only when left justified is selected.

5 Enter “5” for the margin, and press [Enter].

- The display returns to the character input display.

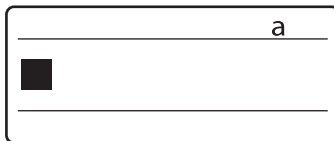

6 Enter the character data and proceed to print.

Memo

The segment (cutting) length setting is restricted by the entered character data. Set it within the range of the displayed message.

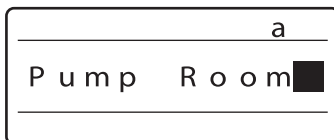

■ Printing a specific page multiple times (Continuous Print)

Assume that you want to produce the following tube segments.

Memo

The number of continuous printings can be set from 1 to 10 for each page.



Fig. 1

In a case such as that shown in Fig. 1, you can obtain the same results by creating the character data shown below and then printing page 2 (“Pump Room”) three times. The function that prints multiple copies of a specific page is called “Continuous Print”.

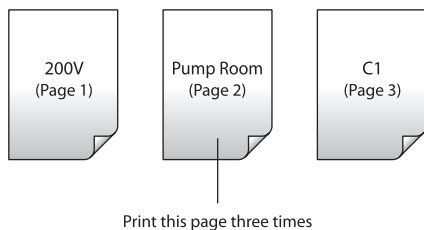
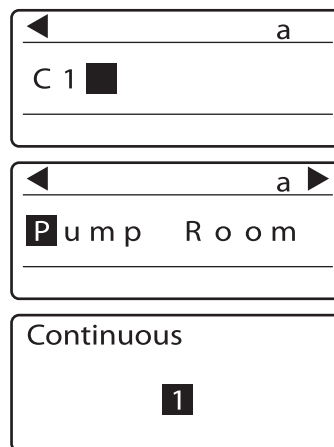

Fig. 2

ex. Produce the tubes shown in Fig. 1.

- 1** Input the character data shown in Fig. 2.
- 2** Display the page for which you wish to use continuous print.
 - Press [Shift] + [◀] or [Shift] + [▶] and display the page in which “Pump Room” has been input.
- 3** Press [Conti.].
 - The continuous printing count entry display appears.





- 4 Input "3" (Continuous Printing Count), and press [Enter].
 - The display returns to the character input display.

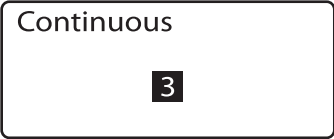

- 5 Perform the printing operation.

 **Canceling continuous print**
 Cancel continuous print by following the procedure described below.

1. Display the page for which you want to cancel continuous print.
 
2. Press [Conti.].
 - The continuous printing count entry display appears.
3. Input "1;" and press [Enter].
 - The display returns to the character entry display, and continuous printing is canceled.

 **Continuous print setting also applies to new pages**
 Refer to Fig. 2 on the previous page. Assume that the continuous print setting has been made for the "C1" page instead of the "Pump Room" page. If a new page is created after the "C1" page, the continuous print setting that is in effect for the "C1" page is also automatically applied to the new page.

■ Generating sequential characters (serial printing)

Assume that you want to produce the following tubes.

Memo

Serial characters can appear in only one place on a page.



Fig. 1

The portion of the character data consisting of numbers from 1 to 9 is incremented (or decremented) by “1” each time it is printed, and is called the “number portion”. The remaining portion of the character data is called the “common portion”. (Fig. 2)

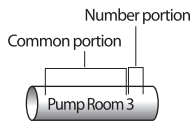

Fig. 2

To print tubes that contain a number portion such as those shown in Fig. 1, it is not necessary to explicitly create 9 pages with character data ranging from “Pump Room 1” to “Pump Room 9” (as shown in Fig. 4). Instead, you need only create one page of character data consisting of a common portion and a number portion as shown in Fig. 3, and then print that page.

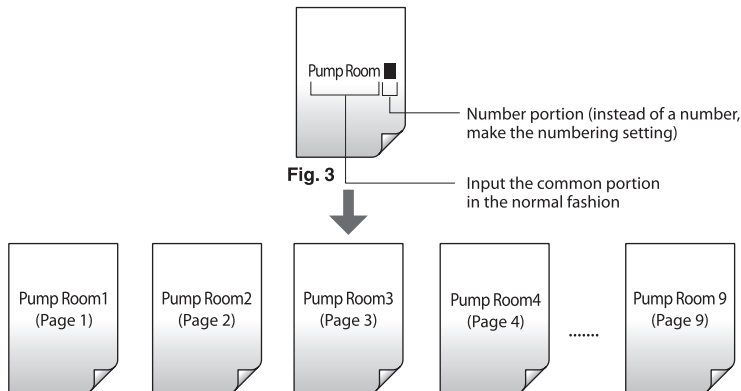
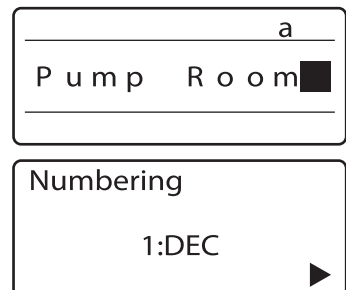

Fig. 4

ex. Produce the tubes shown in Fig. 1.

- 1** Input “Pump Room”.
 - This is the common portion.

- 2** Press [Number].
 - The Numbering display appears.



- 3** Press [◀] or [▶] to select “1:DEC”, and then press [Enter].
- The decimal numbering setting display appears.
 - The display for specifying the start value and end value appears.

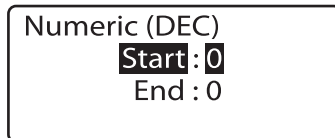

Memo

In addition to decimal numbering, you can also specify hexadecimal or alphabetical numbering. For details, refer to the Memo on the next page, “Various types of numbering print”.

If you accidentally input an incorrect number, press [Back Space] to delete the number and then input the correct one.

- 4** Press [▲] or [▼] to select “Start”, and then input “1”.

Numbering in descending order

For example, if you enter “9” as the start and “5” as the end, you can set up numbering in descending order (9, 8, 7, 6, 5).

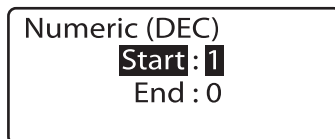

- 5** Press [▲] or [▼] to select “End”, and then input “9”.

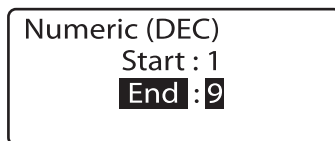

- 6** Press [Enter].

- The number portion has now been input.



The number portion is displayed with a \bar{N} .

- 7** Press [Enter].

- Nine pages, from “Pump Room 1” to “Pump Room 9” are automatically generated.

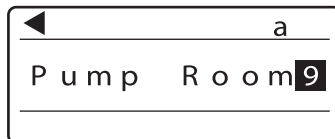

- 8** Perform the printing operation.



Various types of numbering print

The following different types of numbering print are possible. The selection of the type is made in step 3 on the preceding page.

For decimal numbering: Select “Dec” in step 3.

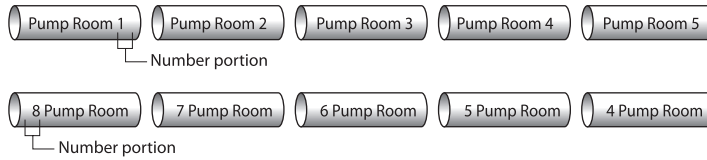

For hexadecimal numbering: Select “Hex” in step 3.

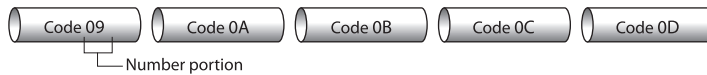

For alphabetical numbering: Select “A - Z” or “a - z” in step 3.

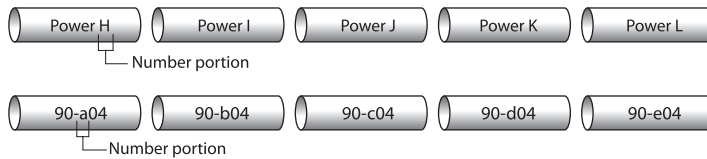

Changing and deleting serial characters

- To remove serial characters, delete the “N” (number symbol) using [Backspace].
- To change the serial character, move the cursor to “N” and press [Number.].
- To enter a common character after a serial character, enter it after “N” before pressing [Enter].



Printing of Multiple Pages

When a blank page(s) is created after deletion of characters on an entire page in the input data comprising multiple pages, the page(s) is fed idly (with blank page(s) printed).

■ Adjusting the printing start position and vertical position

When printing, environmental factors or characteristics of the print media may cause printing to start slightly out of position or to be shifted slightly in the vertical direction so that character data is not printed correctly, even though the correct print media type and size are selected. In such cases, you can shift the printing position slightly up/down or left/right.

Memo

The printing start position can be set independently for each print media.

Case 1

The character alignment is set to “Left” and the margin was set to “3mm”. However, when actually printed, the margin is only 2mm.

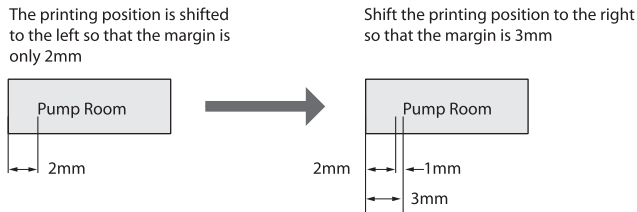

Case 2

Printing is shifted up about 0.5mm.

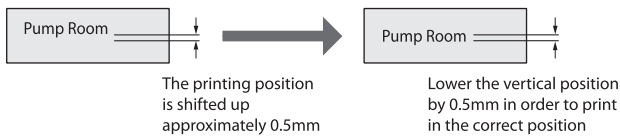

ex. When printing on label tape (12mm wide), the phenomena described in case 1 and case 2 both occur simultaneously. Make the appropriate adjustments.

- 1** Press [Option].
 - The Options display appears. First move the printing start position to the right 1 mm.
- 2** Press [◀] or [▶] to select “1:Adjustment”, and press Adjustment mode [Enter].
 - The Adjustments display appears.
- 3** Press [◀] or [▶] to select “1:End portion”, and press Select media [Enter].
 - The Select media display appears.
- 4** Press [◀] or [▶] to select "4:Label", and press [Enter].
 - The setting adjustment display appears.

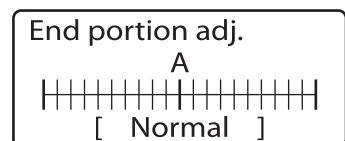
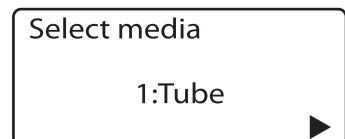
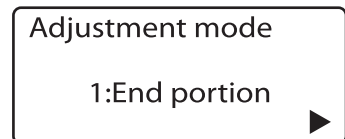
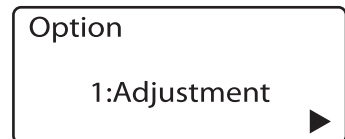

5 Press [▶] four times; “Right 1.0mm” is displayed.

- Pressing [▶] increases the value in steps of 0.25mm.

Memo

Press [◀] to move the printing start position to the left.

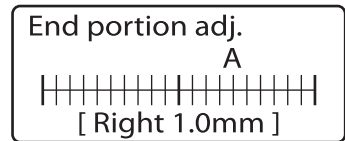

6 Press [Enter].

- The display returns to the character input display. The printing start position has now been shifted 1mm to the right. Next, move the vertical position down 0.5mm.

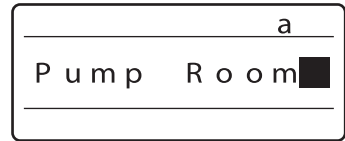

7 Press [Option].

- The Options display appears.

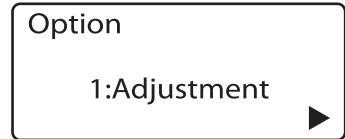

8 Press [◀] or [▶] to select “1:Adjustment”, and press Adjustment mode [Enter].

- The Adjustments display appears.

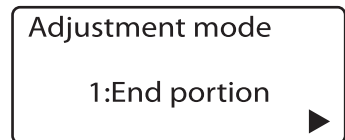

9 Press [◀] or [▶] to select “2:Height”, and press [Enter].

- The Select media display appears.

Memo

The vertical position can be set for each printing media

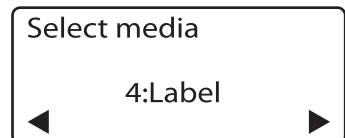

10 Press [◀] or [▶] to select “4:Label”, and press [Enter].

- The Label size display appears.

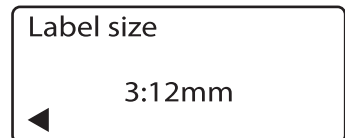

11 Press [◀] or [▶] to select “3:12mm”, and then press [Enter].

- The setting adjustment display appears.

Memo

When the print media is a 4mm I.D. strip, and wrap around tape the size selection is skipped.

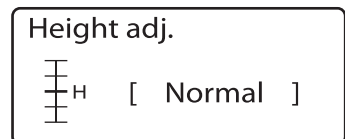

12 Press [▼] two times; “Down 0.5mm” is displayed.

- Pressing [▼] increases the value in steps of 0.25mm.

Memo

Press [▲] to move the vertical position up.

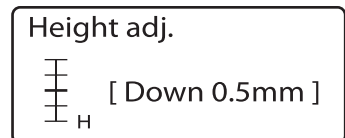

13 Press [Enter].

- The display returns to the character input display. The vertical position has now been shifted down by 0.5mm.

■ Adjusting the printing density

Printing may be too dark or too light in some cases, depending on the environment in which the printer is used and the characteristics of the print media. In such cases, adjust the printing density. The printing density can be adjusted to five levels.

ex. Printing on a tube is too light, so increase the printing density.

1 Press [Option].

- The setting display appears.

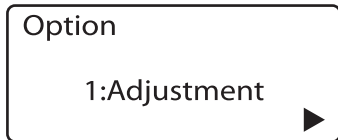

2 Press [◀] or [▶] to select "2:Print option," and then press [Enter].

- The setting display appears.

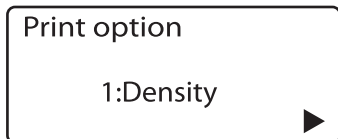

3 Press [◀] or [▶] to select "1:Density," and then press [Enter].

- The Print density selection display appears.

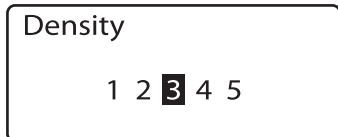

4 Press [▶] two times.

- Print density "1" is the lightest print density, and print density "5" is the darkest print density.



Memo

Press [◀] to make the printing density lighter.

5 Press [Enter].

- The display returns to the character input display. Maximum density is now selected.

4.4 Changing the Cutting Method

■ Half cuts and full cuts

If you examine a long tube that has been printed and output, you will see notches between each segment. These notches allow you to break the individual tube segments apart by hand. The same is true for label tape. The notches make it easy to peel each label off. These notches are called “Half cut”. After the last tube or label tape, a complete cut is made. This is called a “Full cut”.

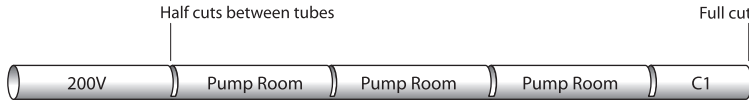

■ Turning off half cuts

Instead of making half cuts, you can print a cutting line. The cutting line can be either a solid line or a dotted line. It is also possible to print without either half cuts or cutting lines.

No half cut, solid cutting line

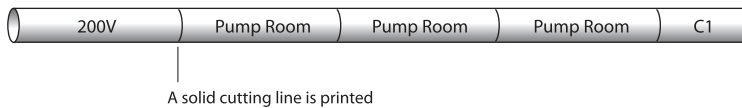

No half cut, dotted cutting line

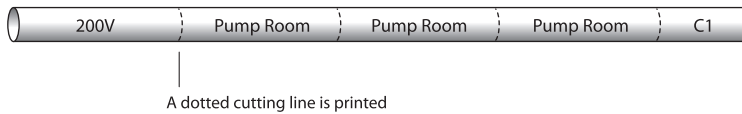

No half cut, no cutting line

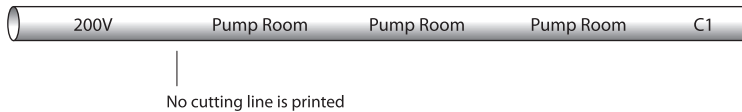

ex. Turn off half cuts and print a dotted cutting line.

1 Press [Option].
• The setting display appears.

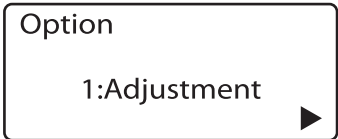

2 Press [◀] or [▶] to select "2:Print options," and press [Enter].
• The setting display appears.

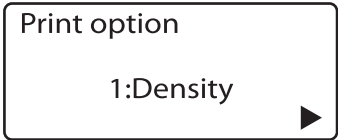

3 Press [◀] or [▶] to select "2:Half-cut" and then press [Enter].
• The Half-cut display appears.

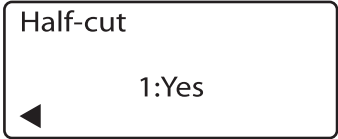

Initially, "Yes" is selected for the half cut setting.

4 Press [◀] or [▶] to select "0:No" and then press [Enter].
• The Cut line display appears.

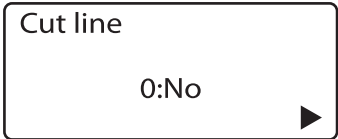

5 Press [◀] or [▶] to select "2:Dotted" and then press a [Enter].
• The display returns to the character input display.

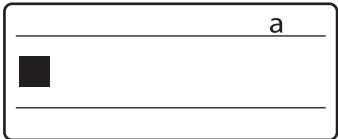

4.5 Other Operations

■ Removing the print media

When changing the print media from tube to label tape, or from label tape to tube, it is necessary to take out the media that is currently set in the printer. However, because the printer feeds tube or label tape into its transport rollers, it is not possible to simply pull out the current media. It is first necessary to perform the operation described below to release the tube or label tape that has been fed into the unit.

Memo

These operations are the same for heat shrink tube, wrap around tape, 4mm I.D. strip, and clear tube.

1 Press [Remove].

- A confirmation display appears.

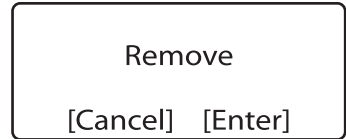

2 Press [Enter].

- The display at right appears, and the tube or label tape is released by the transport rollers.

Memo

After pressing [Enter], use the feed function if the tube or label is not released from the transport roller (unable to remove) even after the printer has stopped. (“When a Tube or Label Tape is Not Ejected/Fed”  page 94))

3 Open the cover.

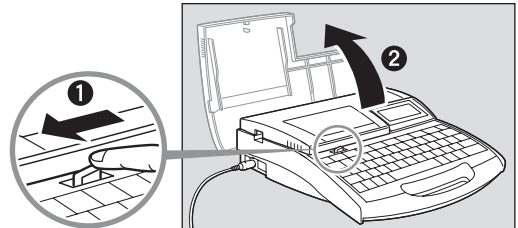

4 (Tube only) Pull the tube out of the tube attachment.

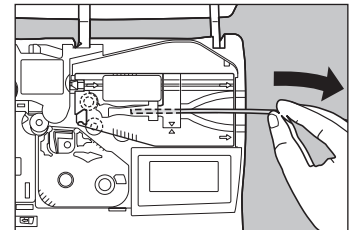

5 Detach the tube attachment or the label tape cassette from the printer.

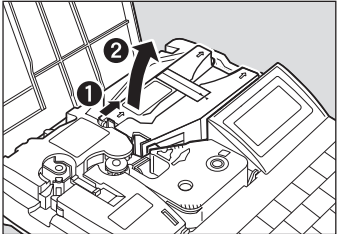

6 Close the cover.

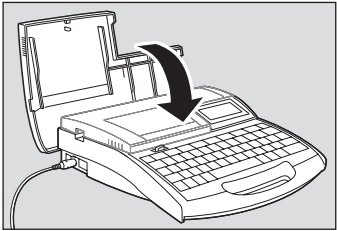

7 Prepare to print.

- See “Part 2 Basic Operation” for information on how to set the print media.

important **Confirm that the ribbon is not slacked.**
Tighten the ribbon if the ribbon is slacked when removing the tube or label tape.

A line drawing showing two hands holding a component of the printer. A curved arrow indicates the direction to turn a knob or lever to adjust the ribbon tension.

■ Changing the display contrast

The display can be difficult to see, depending on the ambient brightness and the viewing angle. If the display is difficult to see, adjust the display contrast. The display contrast can be set to any of nine levels.

ex. Because the display is faint, increase the display contrast two steps.



Intensity of the back light is not adjustable.

1 Press [Option].

- The setting display appears.

Option

1:Adjustment ▶

2 Press [◀] or [▶] to select “1:Adjustment,” and then press Adjustment mode [Enter].

- The Adjustments display appears.

Adjustment mode

1:End portion ▶

3 Press [◀] or [▶] to select “5:Display contrast,” and then press [Enter].

- The Display contrast display appears.

Display contrast

Light |-----| Dark
▲

[▲] indicates the current display contrast.

4 Press [▶] two times.

Memo

Press [◀] to make the display contrast lighter.

Display contrast

Light |-----| Dark
▲

5 Press [Enter].

- The display returns to the character input display.

Restoring the initial settings

It is possible to restore all settings to their initial values.

- 1 Hold down [Delete] while turning the power switch on.
 - The initialization confirmation display appears.

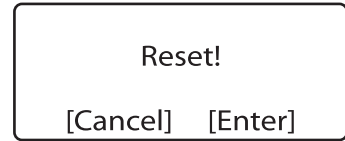

- 2 Press [Enter].
 - After the display shown at right appears, the display returns to the character input display.

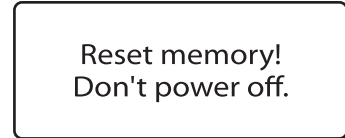

Important

The saved files will be erased when initialized.

The settings are returned to the factory settings when initialized. Therefore, note that all current data and saved files will be erased.

Increasing the printing speed

You can increase the printing speed.

However, printing at a high speed can result in improper printing such as fuzzy characters depending on printer usage environment or material of media. Check the print quality by test printing before actual printing.

1 Press [Option].

- The setting display appears.

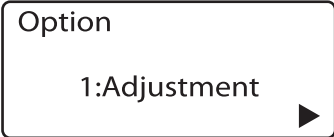

2 Press [◀] or [▶] to select "1:Adjustment," and then press Adjustment mode [Enter].

- The Adjustments display appears.

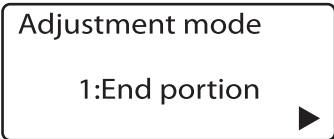

3 Press [◀] or [▶] to select "4:Printing speed," and then press [Enter].

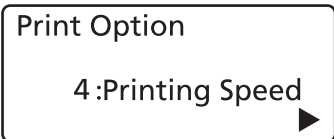

4 Press [◀] or [▶] to select "2:High," and then press [Enter].

- Thus, the printing speed has been increased.

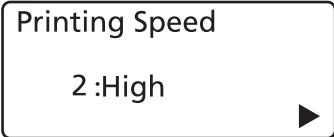

Printing Speed

You can select Low, Standard, or High; however, the actual printing speed varies depending on the media type.

Media	Printing speed setting	(mm/S)	
		When tube is cut	When tube is not cut
Tube Transparent tube	Low	12.5	
	Standard	18.5	
	High	25	20
Shrink tube 4 mm ID	Low	12.5	
	Standard		
Label Wrap-around	High	25	20

Memo

If "High" speed printing with the ambient temperature below 20°C results in fuzzy characters, set the printing speed to "Standard".

Part 5

Maintenance

This section explains how to clear jammed print media, such as a tube or label tape, what action to take if the cutter does not cut anymore, and other maintenance matters.

5.1	<i>If a Tube or Label Tape Becomes Jammed</i>	90
	Action to Take against Media Jam (When the “Media JAM” message is displayed)	90
	Actions to Take against Other Jams (When the “Media JAM” message is not displayed)	92
	When a Tube or Label Tape is Not Ejected/Fed	94
5.2	<i>What To Do If the Cutter Is Getting Blunt.....</i>	96
	Changing the cutting depth	96
5.3	<i>Replacing the Cutter</i>	98
5.4	<i>Replacing the Cassette</i>	100
	Replacing the ribbon cassette.....	100
	Replacing a tube or the label tape cassette	101
5.5	<i>Maintenance.....</i>	102
	Cleaning the printer	102
	Cleaning the transport rollers.....	102
	Cleaning the print head.....	104
	Cleaning/Replacing the tube cleaner....	104

5.1 If a Tube or Label Tape Becomes Jammed

If a tube or tape is jammed during printing, a “Media JAM” message is displayed on the LCD and the printer stops. Remove the jammed tube or tape according to the messages shown on the display.

If you cannot do this because the “Media JAM” message is not shown although a tube or tape is jammed or you have turned off the printer after display of the “Media JAM” message, use the feed function of the printer to remove the jammed printing media.

“Actions to Take against Other Jams (When the “Media JAM” message is not displayed)” (📖 page 92)

■ Action to Take against Media Jam (When the “Media JAM” message is displayed) ■

When the printer stops printing due to a jammed tube or tape and consequently the “Media JAM” message is displayed, remove the jammed tube or tape following the procedure mentioned below.

1 Make sure that the “Media JAM” message is displayed on the LCD.

- If the “Media JAM” message is not displayed or it has disappeared because you have turned off the printer, take an appropriate action according to “Actions to Take against Other Jams (When the “Media JAM” message is not displayed)” (📖 page 92).

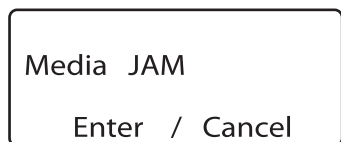

Memo

If you select “Cancel”, the “Media JAM” message disappears and the input display is displayed again, causing you to exit from the jam clearing procedure. In this case, refer to “Actions to Take against Other Jams (When the “Media JAM” message is not displayed)” (📖 page 92).

2 Press the [Enter] key.

- The Feed display appears.



3 Open the cover.

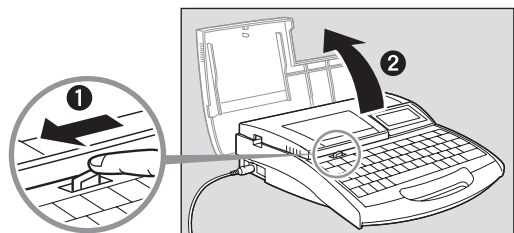

4 Remove the ribbon cassette from the printer.

If the ribbon winds itself around some parts inside the printer and therefore the ribbon cassette cannot be removed, proceed to step 5 without removing it.

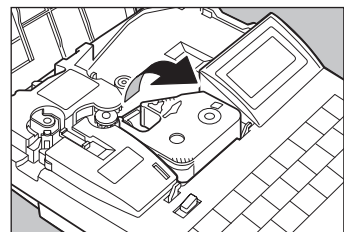

- 5** Remove the label tape if it is loaded.
If the label tape winds itself around some parts and therefore it cannot be removed, proceed to step 6 without removing it.

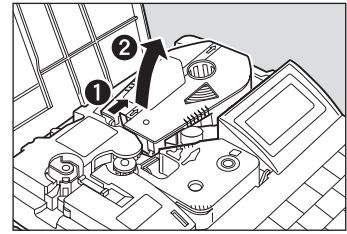

- 6** Close the cover.

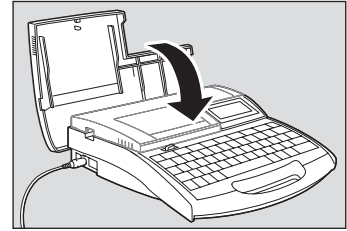

- 7** Pull out the printing media while pressing the [▶] key continuously to feed the tube reverse. If you cannot pull out the printing media by feeding the tube reverse, press the [◀] key to feed the tube forward.

- While you keep pressing the [▶] or [◀] key, the tube is continuously fed reverse or forward.

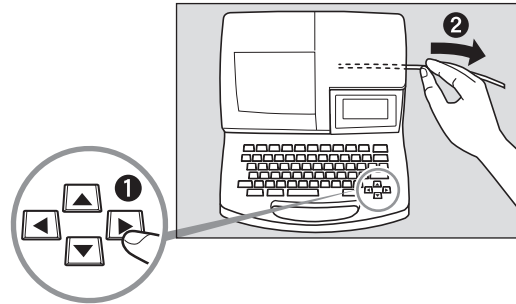

If the ribbon cassette could not be removed in step 4 or the label tape could not be removed in step 5, open the cover and check whether the ribbon cassette or label tape can be removed.

If ribbon cassette or label tape can be removed, remove it and close the cover.

If ribbon cassette or label tape cannot be removed, close the cover and keep pressing the [▶] or [◀] key to check whether the ribbon cassette or label tape can be removed. Open/close the cover and keep pressing the [▶] or [◀] key repeatedly until the ribbon cassette or label tape can be removed.

- 8** Feed the tube reverse (by pressing the [▶] key) or forward (by pressing the [◀] key) repeatedly to pull out the printing media completely.

- 9** Cut out the bent or damaged portion of the jammed printing media or the printed portion of the printing media if it exists.

- Thus, the printing media removal procedure is completed.

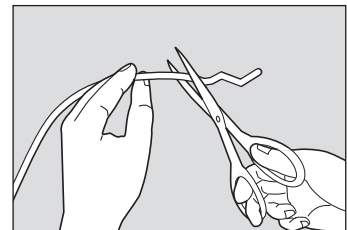

- 10** Make preparations for printing (Part 2 “Basic Operations”).
Open the cover, load the removed ribbon cassette, tube, or label tape, and then close the cover.
Press the [Cancel] key to return to the character input display.

■ Actions to Take against Other Jams (When the “Media JAM” message is not displayed) ■

The tube or tape may wind itself around the roller inside the printer when it is ejected improperly after printing or it is improperly fed after replacement. If you happen to turn off the printer after “Media JAM” message is displayed and as a consequence you cannot clear the jam according to the messages, you can remove the jammed printing media using the Feed function in the maintenance mode.

- 1** When the printer is operating (printing), keep pressing the [Cancel] key until a “peep” sound is heard.
If the printer is not powered, turn it on.

- 2** Open the cover.

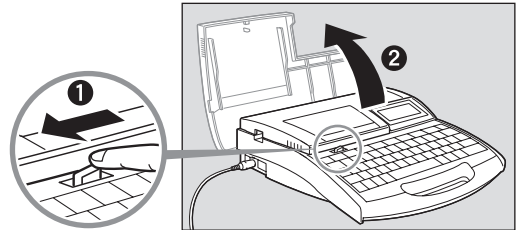

- 3** Remove the ribbon cassette from the printer.
If the ribbon winds itself around some parts inside the printer and therefore the ribbon cassette cannot be removed, proceed to step 4 without removing it.

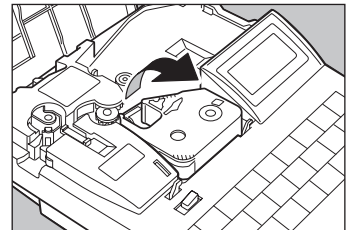

- 4** Remove the label tape if it is loaded.
If the label tape winds itself around some parts and therefore it cannot be removed, proceed to step 5 without removing it.

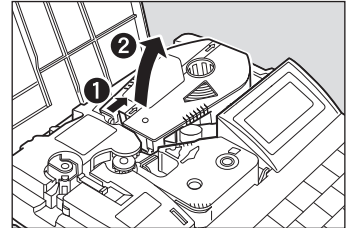

- 5** Close the cover.

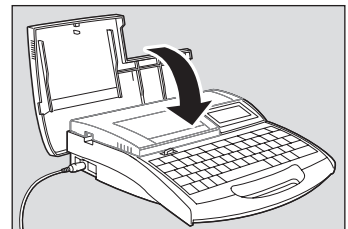

- 6** Press the [Option] key.
 - A function selection display appears.

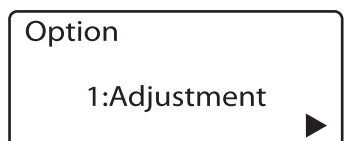

- 7** Select “3: Maintenance” by pressing the [◀] or [▶] key, and then press the [Enter] key.
 - A function selection display appears.

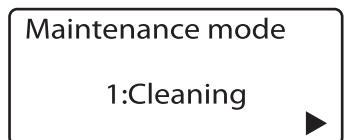

- 8** Select “3: Feed” by pressing the [◀] or [▶] key, and then press the [Enter] key.

- A display indicating how to feed the printing media forward or reverse appears.



- 9** Pull out the printing media while pressing the [▶] key continuously to feed the tube reverse. If you cannot pull out the printing media by feeding the tube reverse, press the [◀] key to feed the tube forward.

- While you keep pressing the [▶] or [◀] key, the printing media is continuously fed reverse or forward.

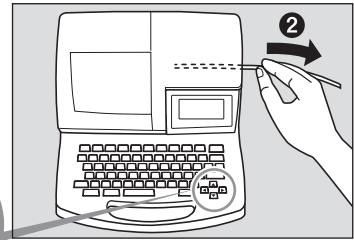
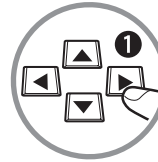

If the ribbon cassette could not be removed in step 3 or the label tape could not be removed in step 4, open the cover and check whether the ribbon cassette or label tape can be removed.

If the ribbon cassette or label tape can be removed, remove it and close the cover.

If ribbon cassette or label tape cannot be removed, close the cover and keep pressing the [▶] or [◀] key to check again whether the ribbon cassette or label tape can be removed. Open/close the cover and keep pressing the [▶] or [◀] key repeatedly until the ribbon cassette or label tape can be removed.

- 10** Feed the tube reverse (by pressing the [▶] key) or forward (by pressing the [◀] key) repeatedly to pull out the printing media completely.

- 11** Cut out the bent or damaged portion of the jammed printing media or the printed portion of the printing media if it exists.

- Thus, the printing media removal procedure is completed.

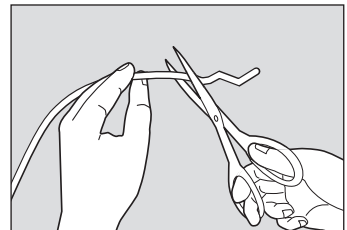

- 12** Make preparations for printing (Part 2 “Basic Operations”).

Open the cover, load the previously removed ribbon cassette, tube, or label tape, and then close the cover.

Press the [Cancel] key to return to the character input display.

■ When a Tube or Label Tape is Not Ejected/Fed

Using the Feed function in the maintenance mode allows you to feed the tube or label tape loaded in the printer.

Note that this function should be used only when the tube or label tape is not ejected or fed properly. Feeding the tube or label tape continuously can damage the printing media or winds the ribbon of the ribbon cassette around other parts, causing a jam.

Memo

For example, use the Feed function in the following cases:

- Printing media is not released from the feed roller even when you press the [Remove] key to replace the printing media.
- The printer is operating but printing media is not ejected after completion of printing.

In this case, the tube or label tape may be jammed inside the printer. Open the cover and check whether the tube or label tape is jammed. If it is jammed, follow the jam removal procedure. Refer to “Actions to Take against Other Jams (When the “Media JAM” message is not displayed)” (📖 page 92).

1 When the printer is operating (printing), keep pressing the [Cancel] key until a “peep” sound is heard.

If the printer is not powered, turn it on.

2 Press the [Option] key.

- A function selection display appears.

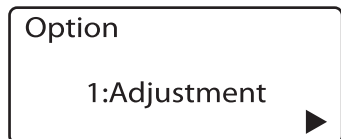

3 Select “3: Maintenance” by pressing the [◀] or [▶] key, and then press the [Enter] key.

- A function selection display appears.

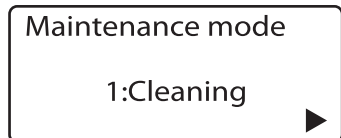

4 Select “3: Feed” by pressing the [◀] or [▶] key, and then press the [Enter] key.

- A display indicating how to feed the printing media forward or reverse appears.



5 Keep pressing the [◀] or [▶] key to feed the printing media to the desired position.

important**Check that paste is not stuck to the outlet of label tape cassette.**

Label tape can be jammed when paste remains stuck to the outlet of label tape cassette. Open the cover and check whether paste is not stuck to the outlet of label tape cassette. If paste is stuck, take it off.

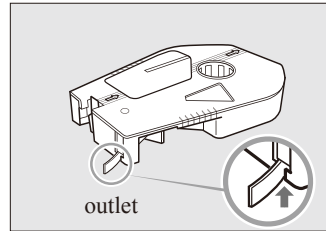
**important****Avoid excessive reverse.**

If you feed the label tape excessively in the reverse direction, the leading edge of the label tape enters the cassette. Refer to “What to do if the label tape becomes stuck inside the cassette” (📖 page 36).

important**Check the ribbon for slack.**

The ribbon of the ribbon cassette can slacken when it is fed reverse. Open the cover and check whether the ribbon is slack. If it is slack, take up the slack.

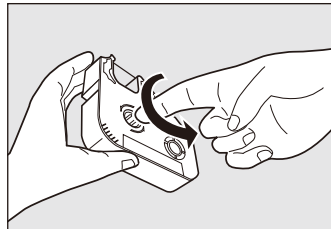

5.2 What To Do If the Cutter Is Getting Blunt

■ Changing the cutting depth

If the cutter does not cut tube or label tape properly, try changing the cutting depth. The cutting depth for half cuts and for full cuts can be adjusted as described below. In addition, these adjustments can be made separately for each type of print media.

Memo

If half cuts are made so deeply that they completely cut through the tube, adjust cutting to a shallower depth. Note that a deeper cutting depth will cause the cutter and the cutter receiver to wear out more quickly.

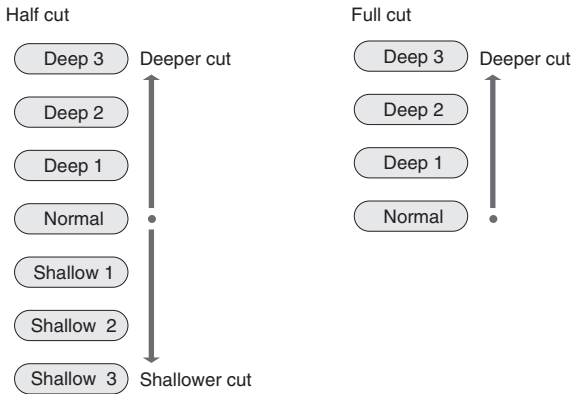

ex. Full cuts of label tape are not complete cuts, so increase the cutting depth by one step.

- 1** Press [Option].
 - The setting display appears.
- 2** Press [◀] or [▶] to select “1:Adjustment,” and press Adjustment mode [Enter].
 - The Adjustments display appears.
- 3** Press [◀] or [▶] to select “4:Full-cut,” and then press Select media [Enter].
 - The Select media display appears.

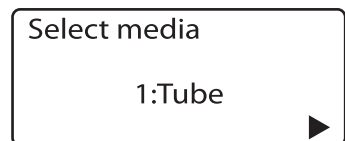
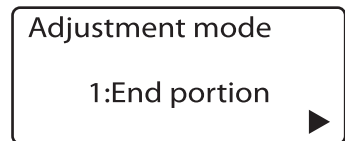
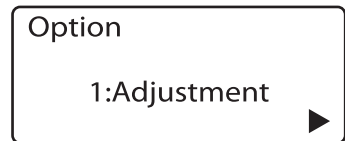

- 4** Press [◀] or [▶] to select “4:Label”, and then press [Enter].
- The Full-cut adjustment display appears.

Memo

The cutting depth can be set for each type of printing media.



- 5** Press [▲] once, so that “Deep 1” appears.
- Each time [▲] is pressed, the cutting depth increases by one.

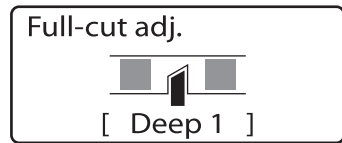

- 6** Press [Enter].
- The display returns to the character input display. The cutting depth is now one step deeper.

**What to do if the cutter still does not cut well (Force full cut)**

If the cutter will not cut well no matter how much you adjust the cutting depth, try using “Force full cut”. When force full cut is performed, the cutter cuts to the deepest depth possible. If the cutter still does not cut even when using force full cut, the cutter needs to be replaced. For details on the replacement procedure, refer to “Replacing the cutter” (page 98).

1. Press [Option]. Option
 - The setting display appears.
2. Press [◀] or [▶] to select “3:Maintenance”, Maintenance mode and press [Enter].
 - The Maintenance selection display appears.
3. Press [◀] or [▶] to select “2:Full-cut”, and then press [Enter].
 - The full cut confirmation display appears.
4. Press [Enter].
 - A full cut is made.

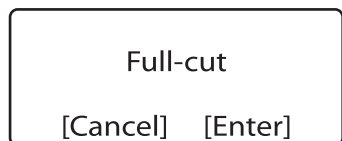
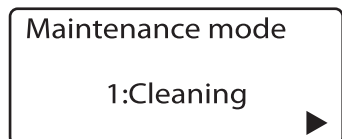
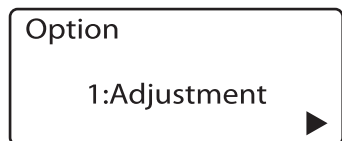

5.3 Replacing the Cutter

If tube or label tape is not fully separated even with forced full cutting (☞ page 97), the cutter should be replaced. When replacing the cutter, be sure to replace the cutter receiver at the same time. Contact your nearest dealer for details on how to obtain a replacement cutter.

Memo

If half cuts are too deep even though the cutting depth has been adjusted to the shallowest level, it is possible that the cutter receiver is worn.



CAUTION

Follow procedures!

The cutter is designed so that you cannot touch it directly, but it is possible that mishandling could expose the blade, creating a risk of injury. Do not attempt any operation that is not described in this manual. Furthermore, be sure to carefully follow the procedures described in this manual.

Dispose of the old cutter immediately

Do not keep the old cutter after you have replaced it; dispose of it right away. The cutter poses a risk of injury to small children, etc.

Discard the removed cutter immediately in compliance with local regulations regarding the disposal of such items.

1 Turn the power switch off.

- Press the “O” side.

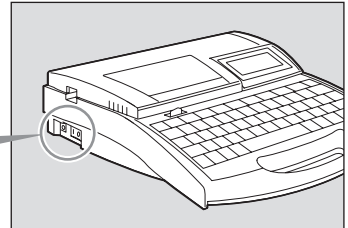

2 Open the cover.

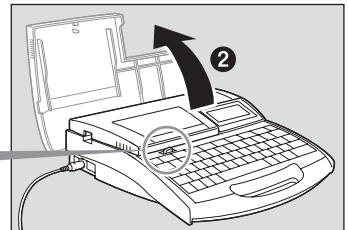

3 Pull out the cutter.

- Dispose of the old cutter right away.

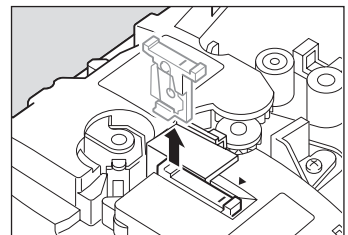

4 Install the new cutter.

- To ensure correct orientation, align the “-” mark on the cutter with the “◀” mark as shown, and insert the cutter all the way in.

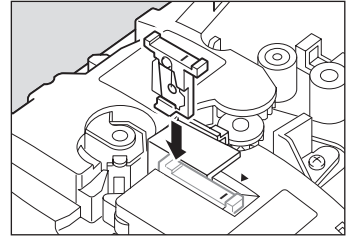
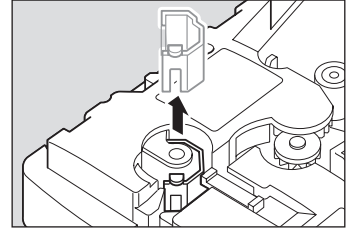
**5** Pull out the cutter receiver.**6** Insert the new cutter receiver.

- Push the cutter receiver in as far as it will go.

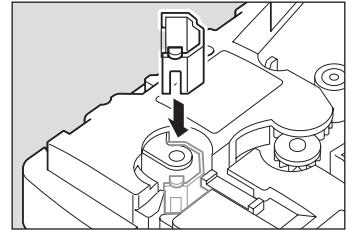
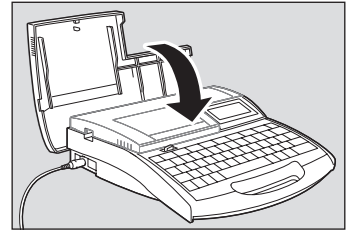
**7** Close the cover.**8** Turn the power switch on.

- Press the “I” side.

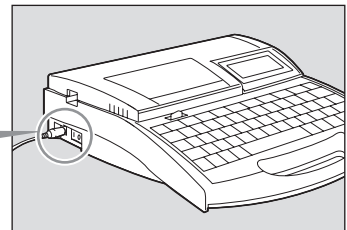
**9** Return the half-cut and full-cut settings to normal.**Important****Replacing the cutter**

Always return the half-cut and full-cut settings to normal. Otherwise, even when cutting correctly, the cutter and cutter receiver will be subject to premature wear.

5.4 Replacing the Cassette

■ Replacing the ribbon cassette

If the message “End of ribbon.” appears while printing is in progress, replace the ribbon cassette as shown below. Contact your nearest dealer to purchase replacement ribbon cassettes.

1 Open the cover.

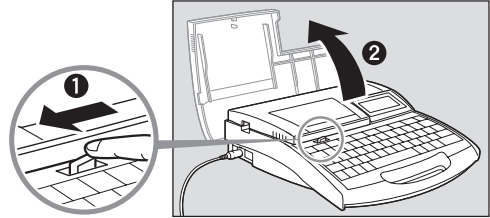

2 Detach the ribbon cassette.

- Pull the cassette out toward you.

Memo

Place the removed ribbon cassette into the plastic bag, then discard it immediately in compliance with local regulations regarding the disposal of such items.

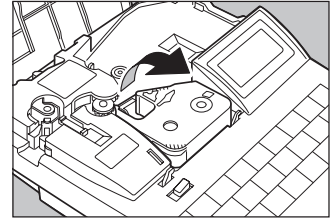

3 Take up the slack in the new ribbon.

- Remove the stopper and then fix the slack in the ribbon.

Memo

The printer cannot detect whether ribbon is present if there is any slack in the ribbon. Be sure to take up any slack.

Memo

Dispose the removed stopper according to local government regulation.

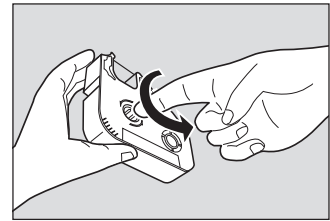

4 Install the new ribbon cassette.

- Push the cassette in all of the way until it clicks into place.

Memo

If the ribbon cassette is loose, the ribbon may not be detected, so be sure to press it in until it clicks.

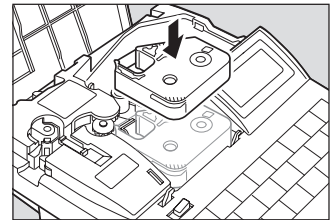

CAUTION Do not touch the connector (metal part)

Do not hold the connection terminal (metal part) of the cassette. Doing so could cause an improper recognition of the cassette.

5 Close the cover.

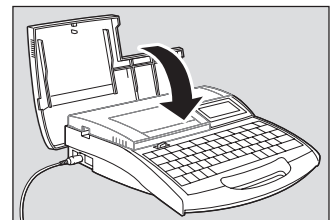

6 Press [Enter].

- Printing resumes from the page following the page that was interrupted.

■ Replacing a tube or the label tape cassette

Remove the tube or label tape cassette as follows, and install a new one.
Contact your dealer if you need to purchase tube or label tape cassettes.

Memo

The procedure for replacing a tube or a label tape cassette also applies when replacing heat shrink tube, wrap around tape or 4mm I.D. strip.
Clear tube is handled in the same way as regular tube.

1 Press [Remove] and then [Enter].

- Media is ejected in the opposite direction.

Memo

After pressing [Enter], use the feed function if the tube or label is not released from the transport roller (unable to remove) even after the printer has stopped. (“When a Tube or Label Tape is Not Ejected/Fed” (page 94))

2 Open the cover.

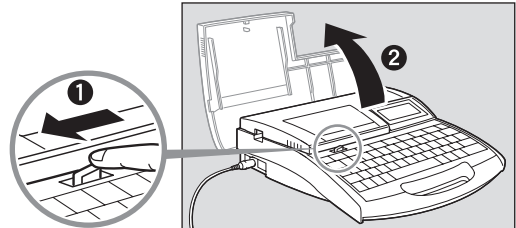

3 Remove the tube attachment or label cassette from the machine.

- While pulling the lever to the right, lift and detach the label tape cassette.

Memo

Dispose the used tubes and label cassettes according to local government regulation.

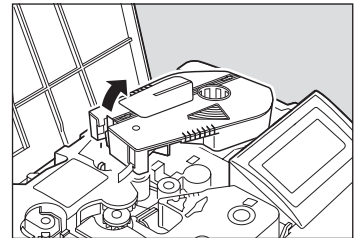

4 Install the new tube or label tape cassette.

- See “Part 2 Basic Operation” for detail.

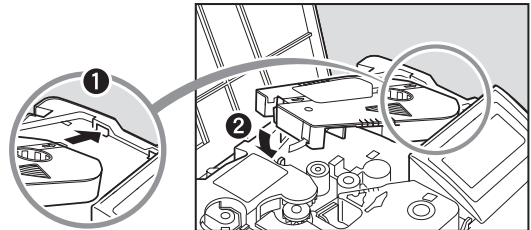

5.5 Maintenance

■ Cleaning the printer

Wipe the body with a cloth that has been dampened with a dilute, mild detergent and then wrung out thoroughly. Do not use alcohol, benzene, or other solvents. Doing so could not only damage the finish, but could also damage the unit itself.

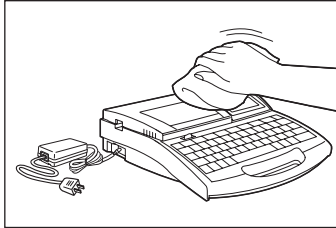

■ Cleaning the transport rollers

Use gauze to wipe away any dirt on the transport rollers. If the transport roller is extremely dirty, place a few drops of a dilute, mild detergent on the gauze, wring the gauze out gently, and then wipe the dirt away. Never use alcohol, benzene, or other solvents. If such chemicals get inside the unit, they could damage it.

1 Press [Option].

- The setting display appears.

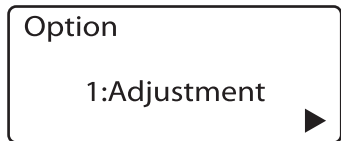

2 Press [◀] or [▶] to select "3:Maintenance", and press Maintenance mode [Enter].

- The Maintenance display appears.

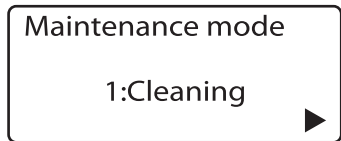

3 Press [◀] or [▶] to select "1:Cleaning," and then press [Enter].

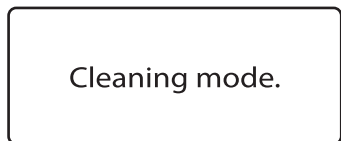

4 Open the cover.

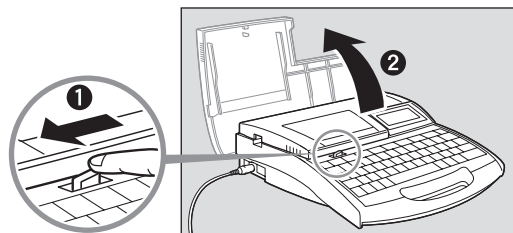

5 Clean the transport rollers.

Transport roller 3 Release lever
To clean transport rollers 2 or 3, first pull the transport roller 3 release lever to the right.

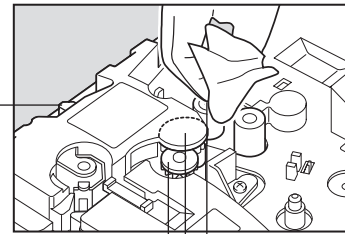

Transport roller 1
Transport roller 2
Transport roller 3

6 Close the cover.

- The transport rollers rotate.

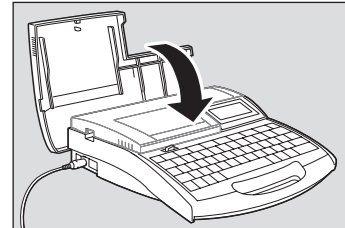

7 Repeat steps 4 to 6.

Memo

The roller rotates one revolution when the cover is opened and closed six times.

8 Press [Cancel].

- The message disappears, and the display returns to the character input display.

■ Cleaning the print head

Use a cotton swab to clean dirt from the print head. Be very careful not to scratch the head. Also, always be sure to turn the power switch off before beginning to clean the print head. If the print head is extremely dirty, place a few drops of a dilute, mild detergent on the cotton swab, and then wipe the dirt away. Never use alcohol, benzene, or other solvents. Such chemicals could damage the unit.

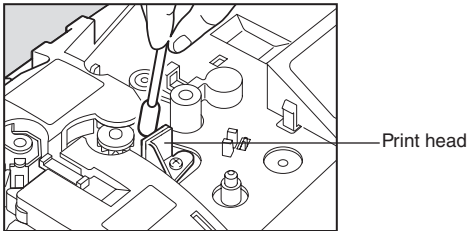

■ Cleaning/Replacing the tube cleaner

The tube attachment has a tube cleaner that removes dirt from the surface of tube. Remove the tube cleaner as shown in the illustration, and then clean the sponge to remove accumulated dirt. When the sponge becomes damaged, replace the tube cleaner. Contact your nearest dealer to purchase replacement tube cleaners.

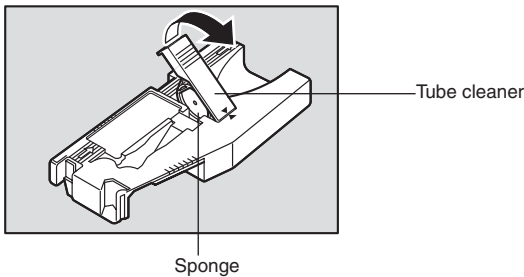

Part 6

Appendices

These appendices describe consumable supplies and options, the list of symbols, and the main specifications of the printer.

6.1 Consumable Supplies and Options	106
Consumable supplies	106
Options	107
6.2 Message List.....	108
6.3 Troubleshooting.....	109
6.4 List of Symbols.....	111
6.5 List of Function	112
6.6 Main Specifications	113

6.1 Consumable Supplies and Options

Consumable supplies

The consumable supplies used by the printer are listed below. Contact your nearest dealer to purchase supplies.

Tube

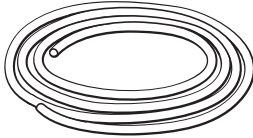

Purchase any commercially available tube with an inner diameter ranging from ϕ 2.5mm to 5.2mm. The 0.5 mm-thick tube can be used with this printer.

Ink ribbon cassette (black, white)

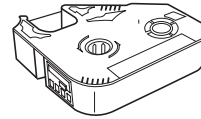

Purchase only special cassettes intended for use with the printer.

Heat shrink tube cassette (white, yellow)

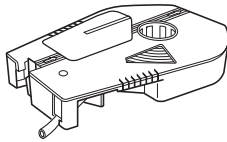

Purchase a special cassette.

Label tape cassette (white, yellow, silver)

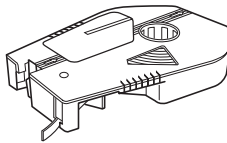

Purchase a special cassette.

Wrap around tape cassette (white).

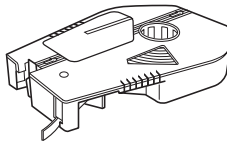

Purchase a special cassette.

4mm I.D. strip cassette (white, yellow)

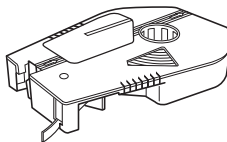

Purchase a special cassette.

List of consumable supplies

Cassettes

Ink ribbon cassette (black, white)

Label tape cassette (white)

6mm

9mm

12mm

Label tape cassette (yellow)

6mm

9mm

12mm

Label tape cassette (silver)

6mm

9mm

12mm

Heat shrink tube cassette (2:1 shrinkage)

ϕ 3.2mm • White

• Yellow

ϕ 4.8mm • White

• Yellow

ϕ 6.4mm • White

• Yellow

Heat shrink tube cassette (3:1 shrinkage)

ϕ 3.0mm • White

• Yellow

ϕ 6.0mm • White

• Yellow

Wrap around tape (white)

4mm I.D. strip (white, yellow)

Miscellaneous

Cutter set

Cleaner set

Warmer cleaner set

Options

The following options are available. Contact your nearest dealer for details.

Tube Warmer

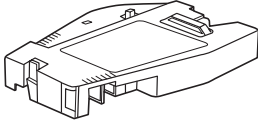

Tube Warmer warms the tube that has hardened with cold.

Using the tube warmer enables clear printing in low temperature environment.

List of options

Tube Warmer

Tube Attachment

AC adapter

Soft case

Hard case

Wrap-Around Tape Guide

Hard Case

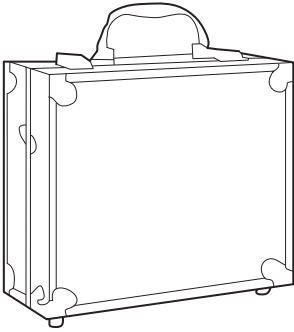

Hard Case designed to protect this printer from impact. You can print characters with the printer put in this case.

6.2 Message List

Message	Description	Action
Input value out of range.	An attempt was made to input a value that is outside of the settable range.	Make the correct setting according to the pages 73 and 74.
Not enough memory. Character input is no longer possible.	An attempt was made to input characters when there was insufficient free space in memory.	Delete some input data to free up some space. See page 32.
Length exceeded. Input data exceeds set length.	Entered character length exceeded the specified cut tube length.	Make the correct setting according to page 72.
Not enough memory. Cannot save any more files.	An attempt was made to save a file while there was insufficient free space remaining.	Delete any unnecessary files to create free space. See page 67.
Already 20 files!	An attempt was made to save more than 20 files.	Either delete any unnecessary files and then save the desired files.
No files.	An attempt was made to load or delete a file even though no files have been saved.	Save the file once more. See page 65.
No media.	An attempt was made to print while no printing media has been loaded.	Load the print media and then press [Enter] to begin printing. See page 24.
No Ribbon cassette.	An attempt was made to print while no ribbon cassette was installed.	Install a ribbon cassette. See page 24.
End of media. Pull out print media.	The end of the printing media was reached while printing was in progress.	Take out the printing media from the printer, and replace it with new printing media. Set the media according to pages 28 and 35, and then press [Enter] to start printing.
End of ribbon Replace ribbon cassette.	The end of the ribbon cassette was reached while printing was in progress.	Install a new ribbon cassette, and then press [Enter] to resume printing. See page 100.
Cannot initialize print head position.	It is impossible to initialize the print head position for some reason.	Press [Enter]. If the same message appears again, contact your dealer.
Cannot move print head to print position.	It is impossible to move the print head to the printing position for some reason.	Press [Enter]. If the same message appears again, contact your dealer.
Cannot initialize cut position.	It is impossible to initialize the cutter position for some reason.	Press [Enter]. If the same message appears again, contact your dealer.
Close cover and press any key.	An operation was attempted while the cover was open.	Close the cover and press any key. See pages 27 and 35.
Memory backup battery low. Contact dealer.	The memory backup batteries do not have adequate capacity.	Contact your dealer.
Memory backup battery exhausted. Resetting memory.	Because the memory backup batteries do not have adequate capacity, the data settings have been initialized.	Contact your dealer.
Media JAM Enter/Cancel	Tube or label tape is jammed.	Refer to “If a Tube or Label Tape Becomes Jammed” and remove the jammed object.
Printing... Ribbon will end soon	Remaining ribbon is low when printing. (approximately 10m remaining)	Have a new ribbon cassette ready. Replace with new ribbon cassette if printing a long document. See page 100.
No ribbon information. No ribbon amount displayed. Press enter	The printer could not properly communicate with the ribbon cassette.	Follow the instruction on the screen.

6.3 Troubleshooting

Symptoms	Cause	Action
The display remains blank when the power is turned on.	The AC adapter is not connected properly.	Turn the power switch off, and then make sure either that the AC adapter is securely plugged into the power outlet and is connected to the main unit. Then turn the power back on.
	You are not using an AC adapter that is made for use with the printer.	Use an AC adapter that is specifically intended for the printer. Using another AC adapter could result in circuit damage or overheating.
	A cause other than the above.	Restore all settings to their initial values. (page 87)
The startup display remains on the display; the input display does not appear.	Bad input data.	Restore all settings to their initial values. (page 87)
The printer does not print, or does not print correctly.	No character data has been input.	The printing operation cannot be performed if no character data has been input. Either input character data, or else load a file and prepare character data.
	The size of the printing media that was selected for printing does not match the size of the printing media that has actually been loaded in the printer.	Confirm the size of the printing media that is loaded in the printer, and then select the same size.
	The printing start position and the printing vertical position are not set correctly.	Refer to “Adjusting the printing start position and vertical position” (page 79) and make the correct settings.
	The ribbon cassette has not been set correctly.	Detach the ribbon cassette, take up the slack, and then reinstall the ribbon cassette.
	The tube attachment or label tape cassette has not been installed correctly.	Detach the tube attachment or the label tape cassette and then install it again.
	The tube or label tape is crushed, twisted, or otherwise misshapen.	Cut off the misshaped portion and then install the media again. Use printing media that is not misshaped.
	The tube or label tape is dirty.	Remove the dirt.
	The transport rollers are dirty.	Refer to “Cleaning the transport rollers” (page 102) and clean the transport rollers.
	The print head is dirty.	Refer to “Cleaning the print head” (page 104) and clean the print head.
	Tube cleaner is dirty.	Refer to “Cleaning/Replacing the tube cleaner” (page 104) and wipe the dirt with sponge.
	Tube cleaner is worn.	Replace with new cleaner. Contact your nearest dealer to purchase replacement tube cleaners.

Symptoms	Cause	Action
Surface of the print media is dirty.	When transporting after printing, the printed material touched the ribbon cassette and smeared.	Wipe the dirt from the printed material with dry cloth.
The tube or label tape is not fed into the printer.	The cover is open.	Close the cover.
	The load placed on the tube when supplying the tube is too heavy.	Minimize the load that is placed on the tube. The tube cannot be transported if the load exceeds 4.9N (500gf).
	The transport rollers are dirty, causing the media to slip.	Refer to “Cleaning the transport rollers” (page 102) and clean the transport rollers.
	The tube or label tape transport path is dirty.	Clean away the dirt.
The print media is not ejected.	The operating environment is unsuitable for the printer.	Use the printer in an environment where the temperature ranges from 15°C to 32.5°C, and the humidity ranges from 35% to 85%RH. If the optional Tube Warmer is used, the printer can be used in an environment as cool as 5°C.
	The print media is jammed.	Refer to “If a Tube or Label Tape Becomes Jammed” (page 90) and clear the jam.
The tube is cut at an angle. Full cutting cannot be made on 12mm label tape.	The tube is transported to the printer twisted.	If the tube is curled, it cannot be transported straight and the end may be cut at an angle. Untwist the tube as much as possible before printing especially when printing on a long tube.
	Cut is crooked because something is preventing proper ejection at the ejection end of the printer.	Do not place objects at the ejection end of the printer when printing.
Half cuts cannot be made.	The cutter or the cutter receiver is not installed correctly.	Refer to “Replacing the cutter” (page 98) and install the cutter correctly.
	The cutter depth is not set properly.	Refer to “Changing the cutting depth” (page 96) and make the appropriate adjustments.
	The cutter is worn.	Refer to “Replacing the cutter” (page 98) and replace both the cutter and the cutter receiver.
Half cuts are made too deep.	The cutter receiver is worn.	Refer to “Replacing the cutter” (page 98) and replace both the cutter and the cutter receiver.
	The cutter or the cutter receiver is not installed correctly.	Refer to “Replacing the cutter” (page 98) and install the cutter correctly.
	The cutter depth is not set properly.	Refer to “Changing the cutting depth” (page 96) and make the appropriate adjustments.
Full cuts cannot be made	The cutter is worn.	Refer to “Replacing the cutter” (page 98) and replace both the cutter and the cutter receiver.

6.4 *List of Symbols*

Å	Æ	Ç	É	Ñ	á	å	æ	ì	í
ñ	ò	ó	ú	ÿ	¥	¢	£	Pt	f
̣	◊	¿	¡	¬	⌈	«	»	μ	Ω

6.5 List of Function

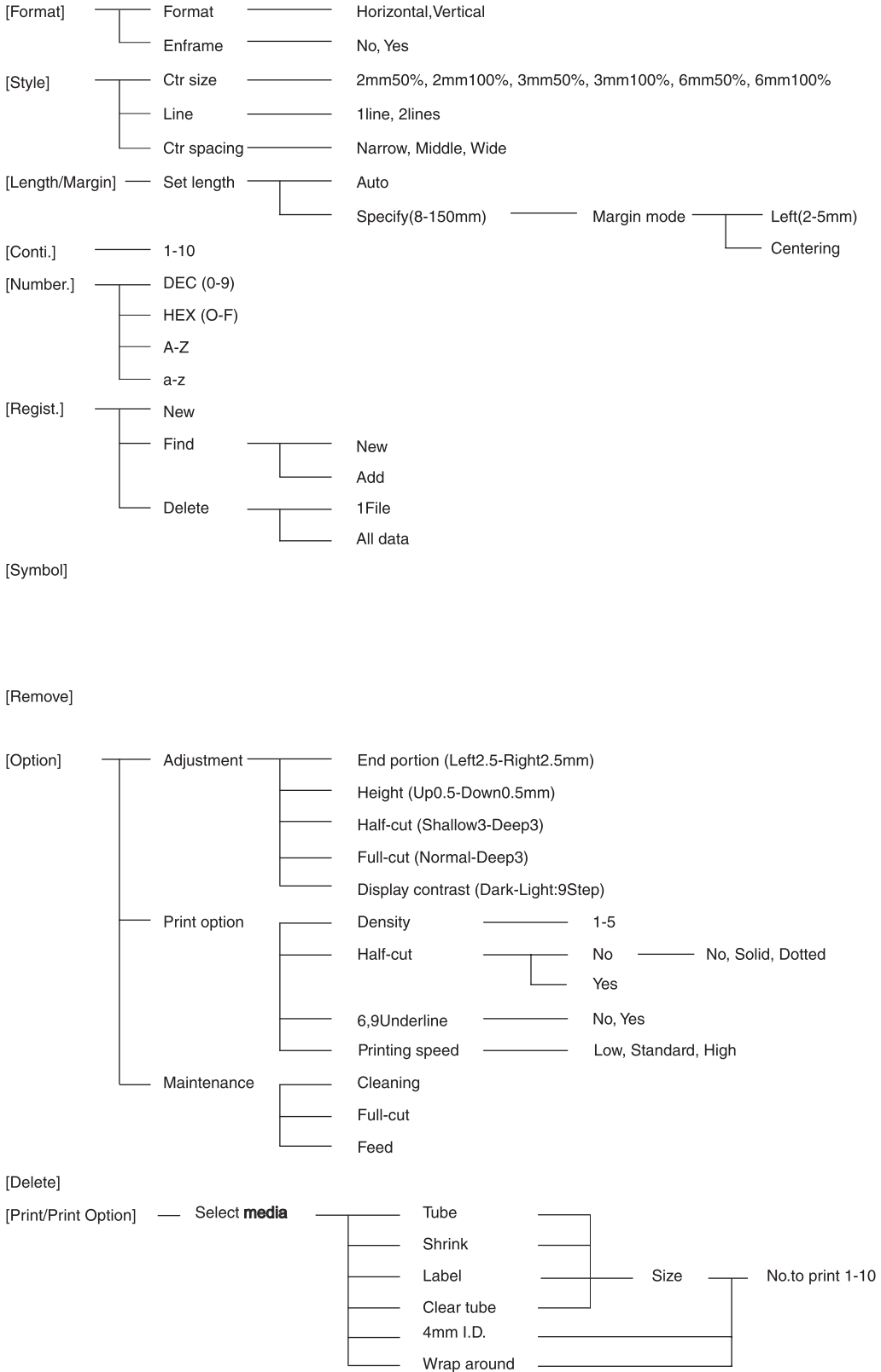

6.6 Main Specifications

Printing method.....	Thermal transfer using one-line head
Resolution	300dpi
Printing speed.....	25 mm/s(max.)
Throughput.....	35 tubes/min in High (printing speed) mode, 30 tubes/min in Standard (printing speed) mode, 21 tubes/min in Low (printing speed) mode *
	* Tube cutting length: 20 mm, printing 5 characters of 3mm full size, making half cuts
Ink ribbon.....	Special cassettes (black or white), Length - black: 100 m, white: 85 m
Character print size	2, 3 and 6 mm (each full- and half-width)
Display system.....	LCD (160 x 64 dots) with backlight
Number of displayable characters.....	Entry data 10 characters x 2 lines (at normal size)
Internal memory.....	Printing character data storage: approx. 2,500 characters
	File storage memory: approx. 7,500 characters
	Note: Internal battery preserves memory for about 5 years
Cutting method.....	Automatic half cut, automatic full cut
Power supply.....	Custom AC adapter (N14584)
	Input voltage: 100 to 240 V AC, 50/60Hz
Operating environment	15 to 32.5°C, * 10 to 85% RH
	* Usable at lower temperatures (5 to 18°C) with the optional Tube Warmer installed
Storage environment	5 to 35°C, 10 to 90% RH
External dimensions.....	250 (W) x 300 (D) x 85 (H) mm
Weight.....	2.0 kg (not including accessories)

Printing Media

Tube	Tube: ϕ 2.5 to 5.2 mm inside diameter, 0.5 mm thickness
	* Before using a tube, be sure to check whether characters can be printed on it.
Heat shrink tube	Cassettes (white, yellow)
	2:1 shrinkage: ϕ 3.2, ϕ 4.8 or ϕ 6.4 mm diameter, 5 m length
	3:1 shrinkage: ϕ 3.0 or ϕ 6.0 mm diameter, 5 m length
Label tape.....	Cassettes (white, yellow, silver) in 6, 9 or 12 mm width, 30 m length (ex. silver: 27 m length)
Wrap around tape	Cassettes (white for printing part, other part is transparent) 8 m rolls, 33 mm length, width settable from 8 to 150 mm by cutting length setting
4mm I.D. strip.....	Cassettes (white, yellow) in 4.0 mm width, 5m length

